

Patterns from
Wild Blooms & Colorful Creatures

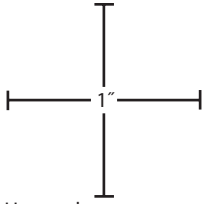

Use a ruler to measure these inch marks to verify that printout is correctly sized.

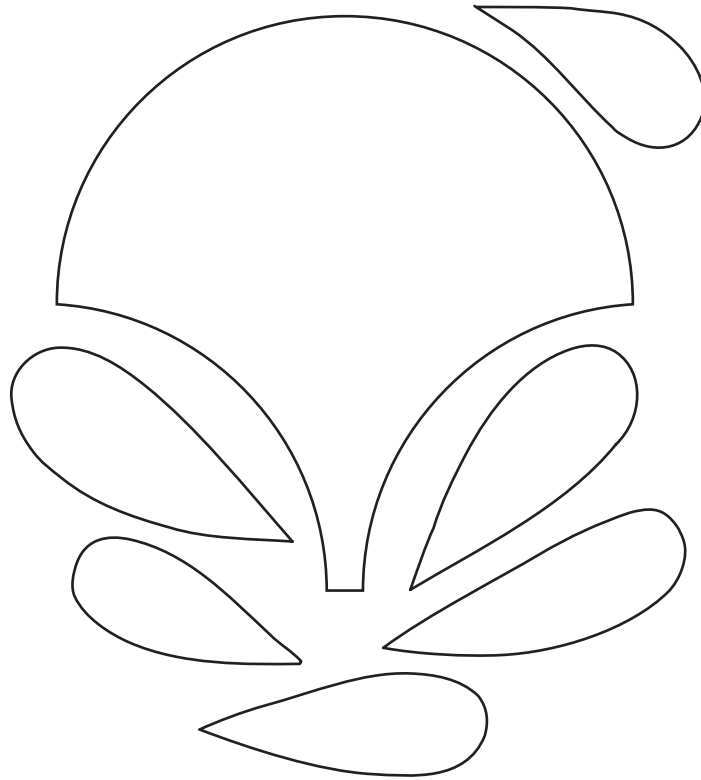

Clamshell Garden Runner appliqué patterns

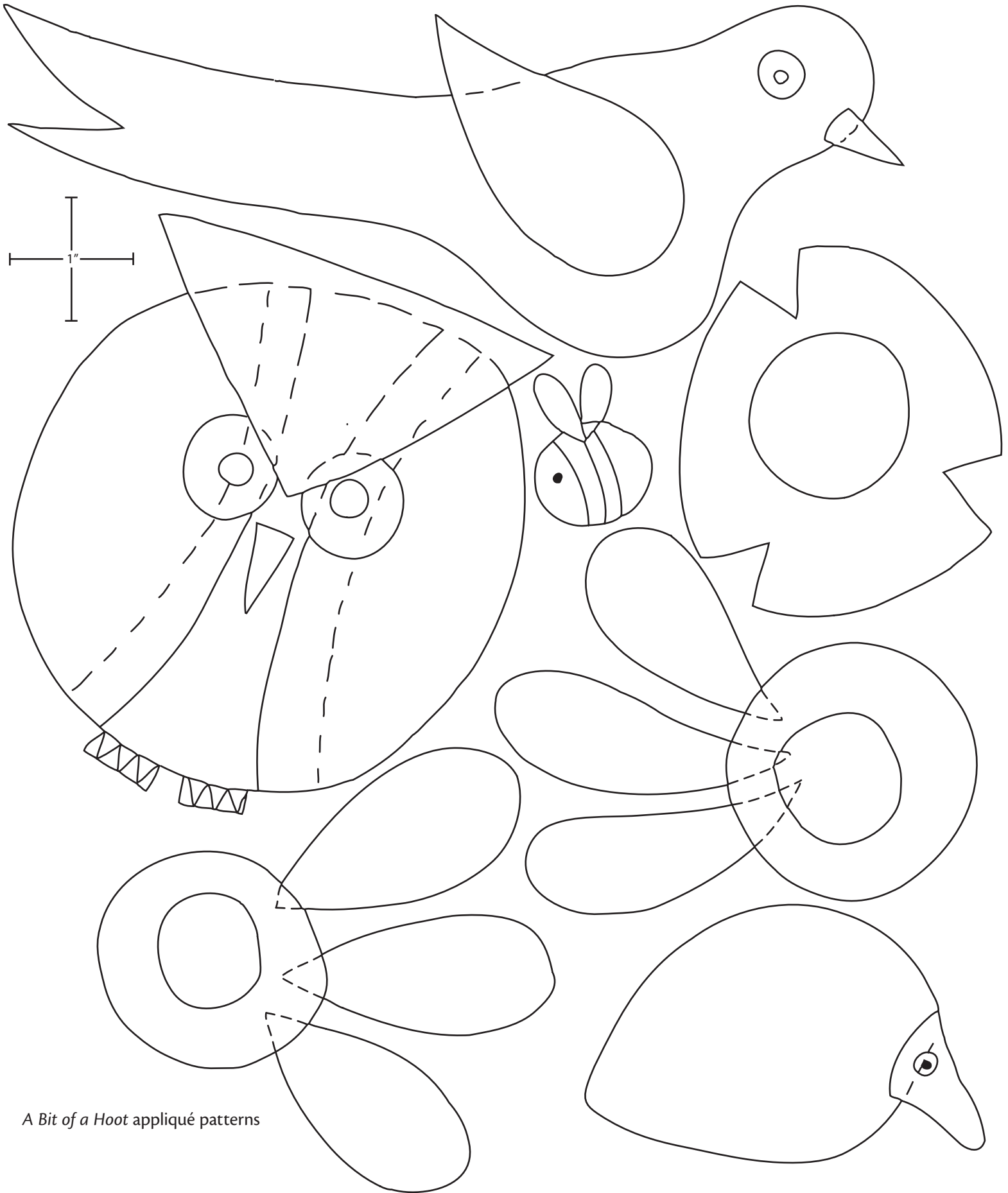

A Bit of a Hoot appliqué patterns

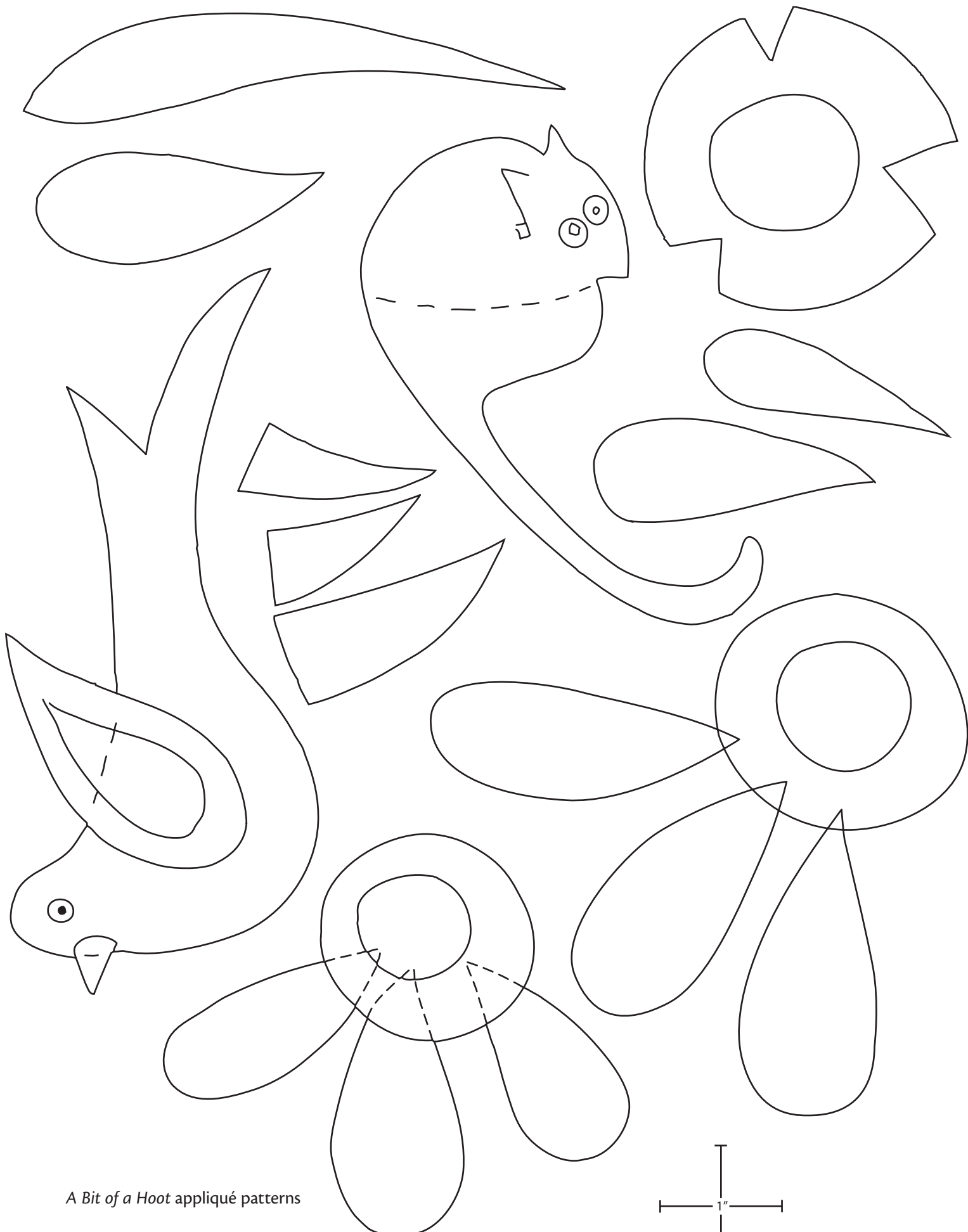

A Bit of a Hoot appliqué patterns

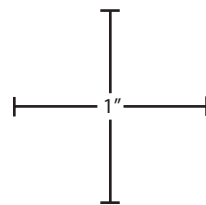

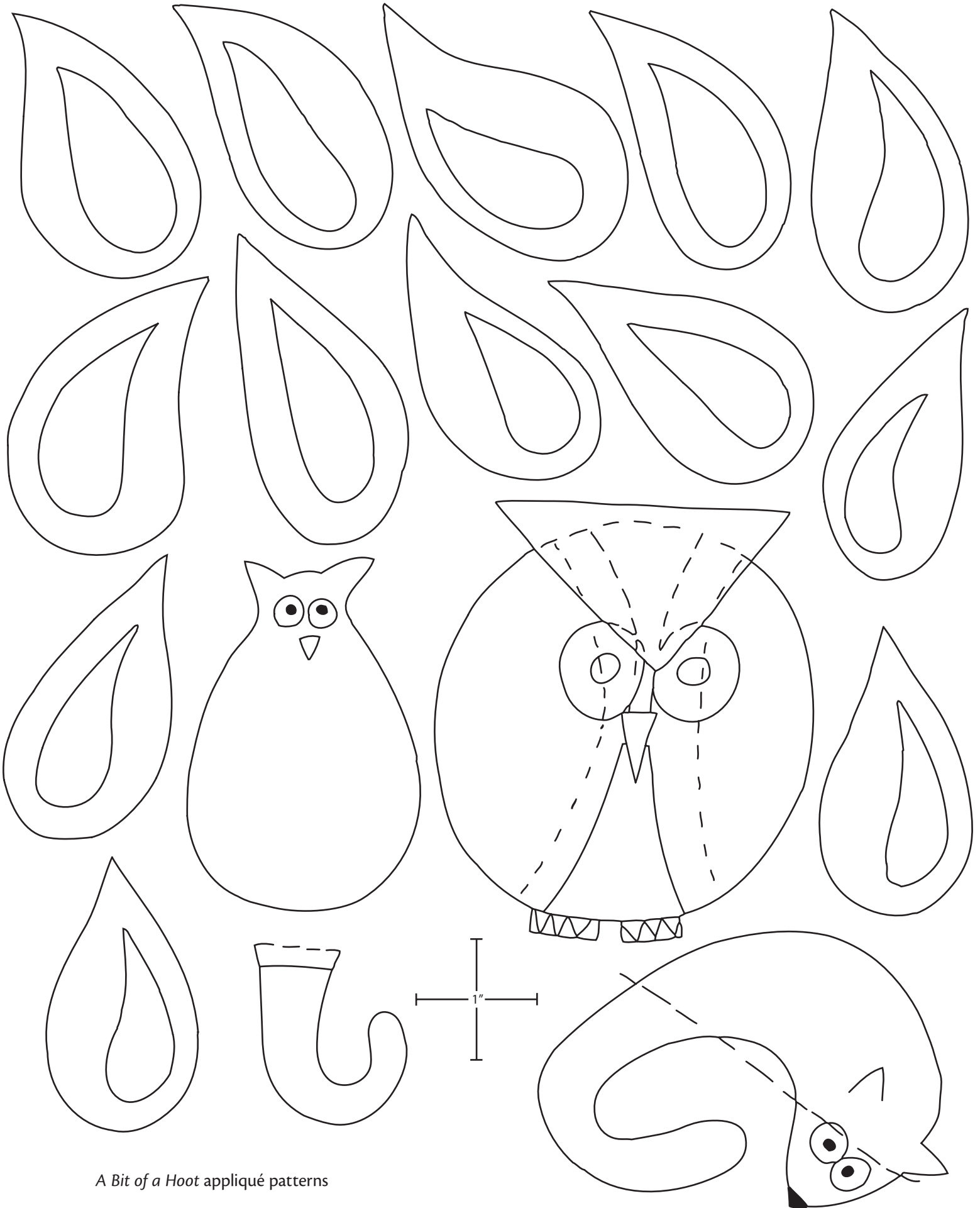

A Bit of a Hoot appliqué patterns

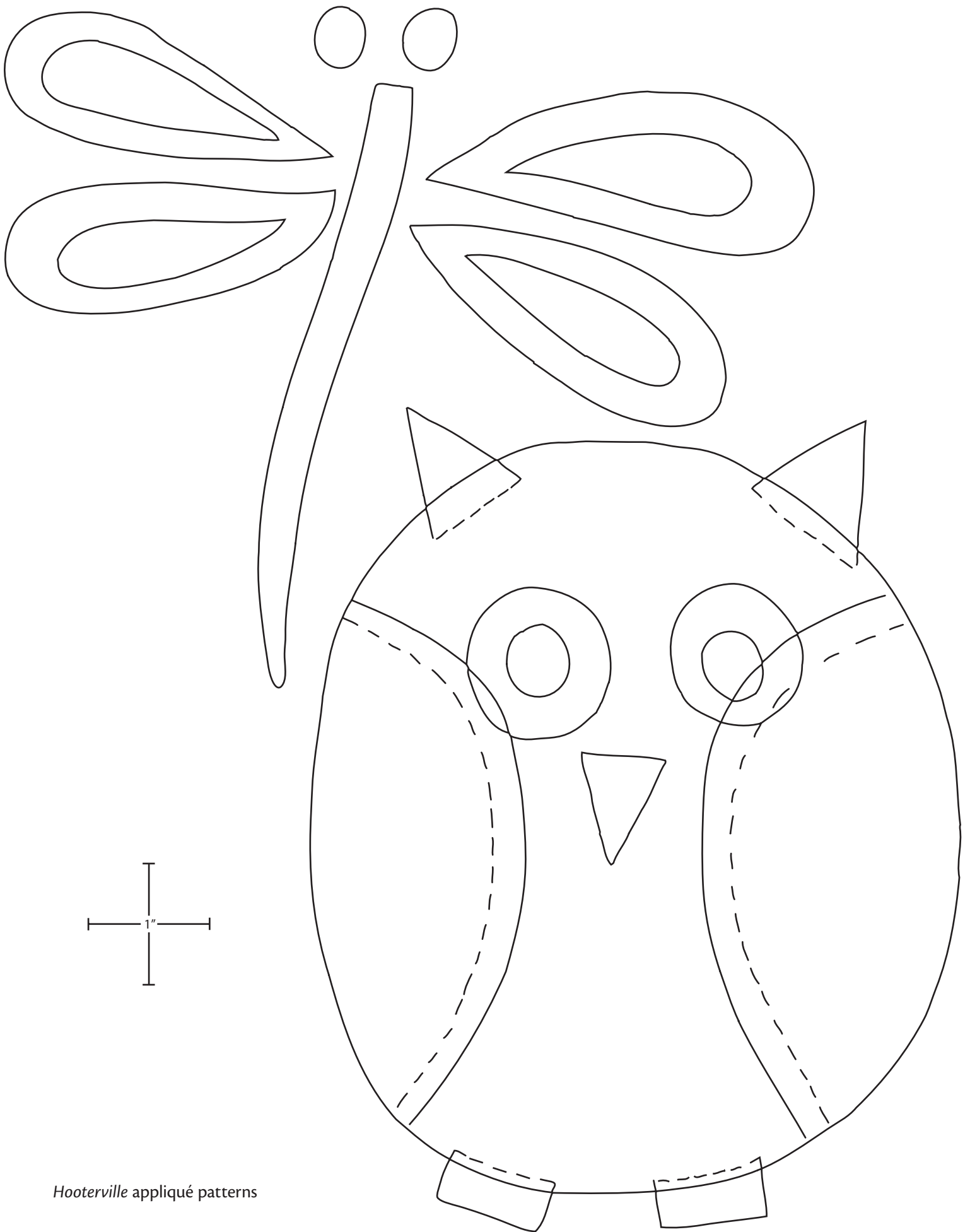

Hooterville appliqué patterns

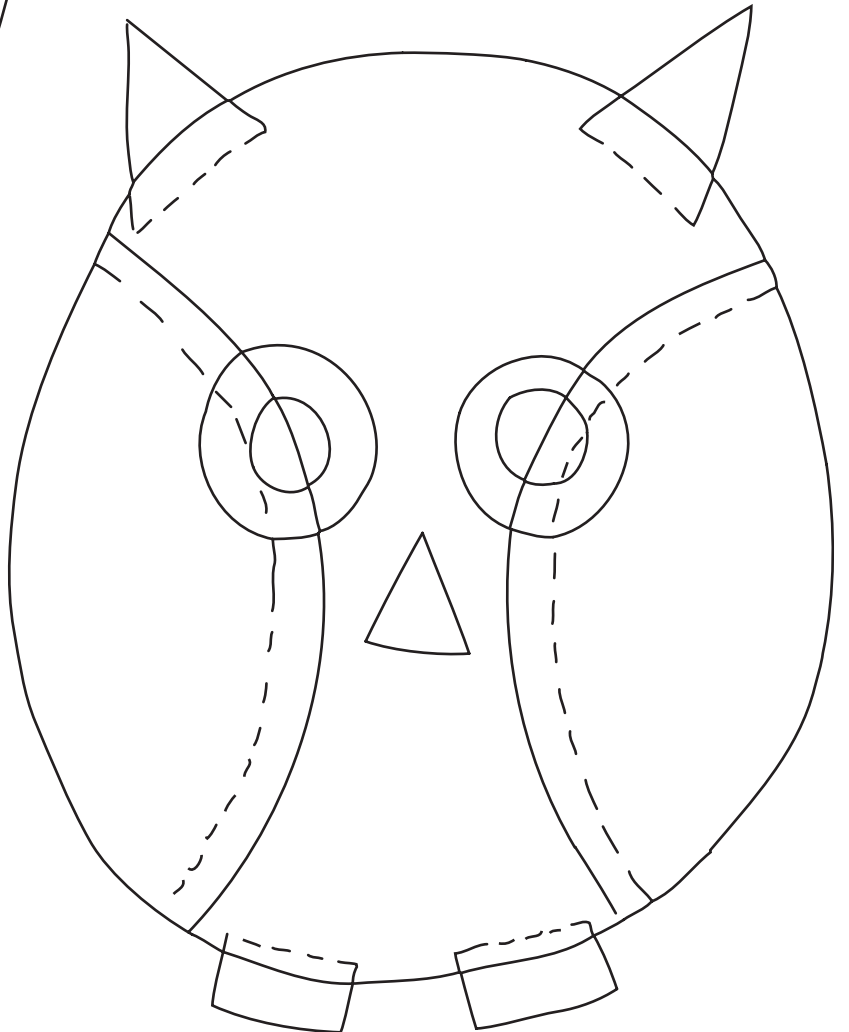
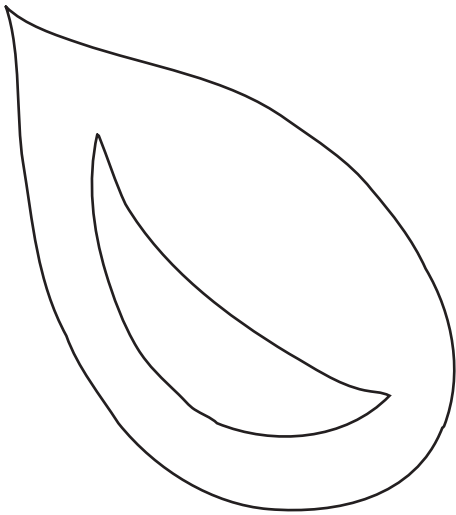
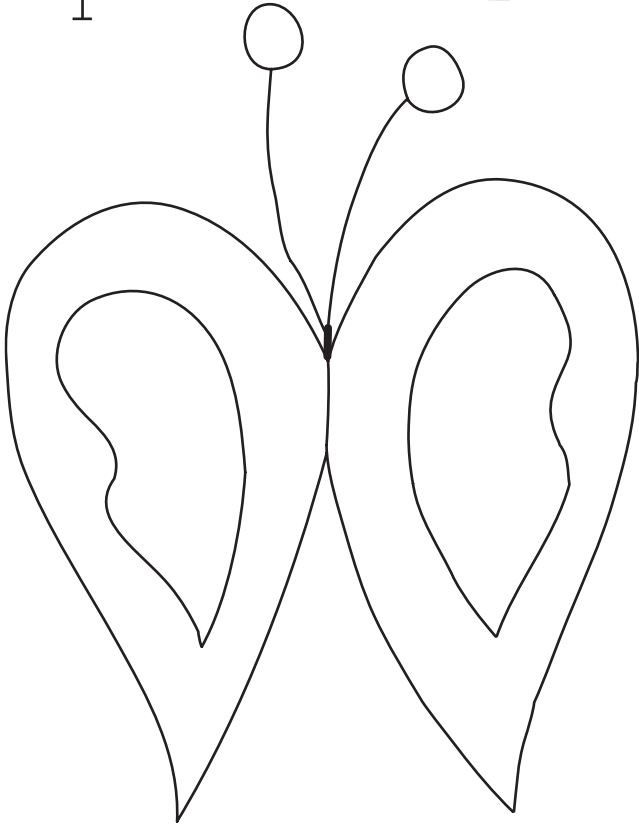
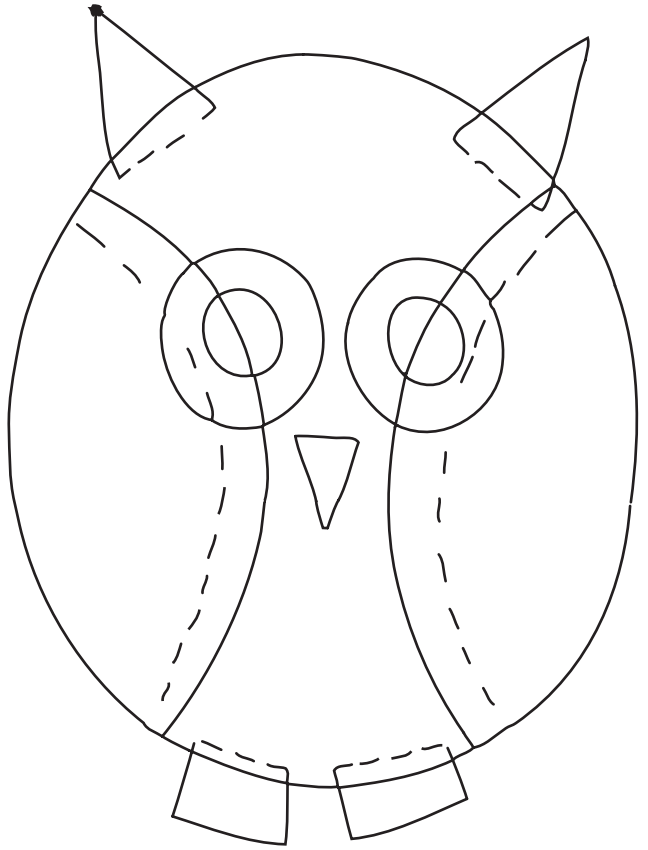
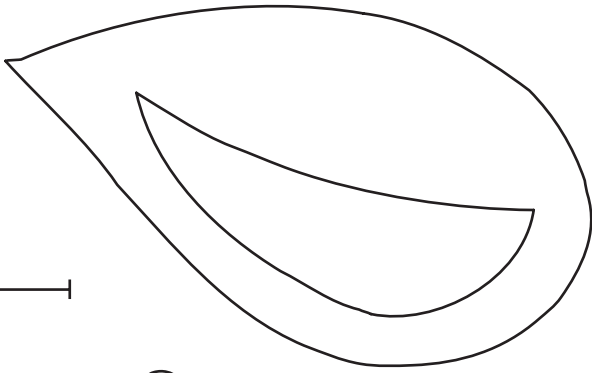
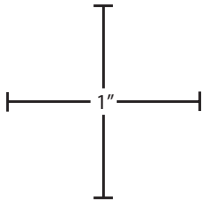

Hooterville appliqué patterns

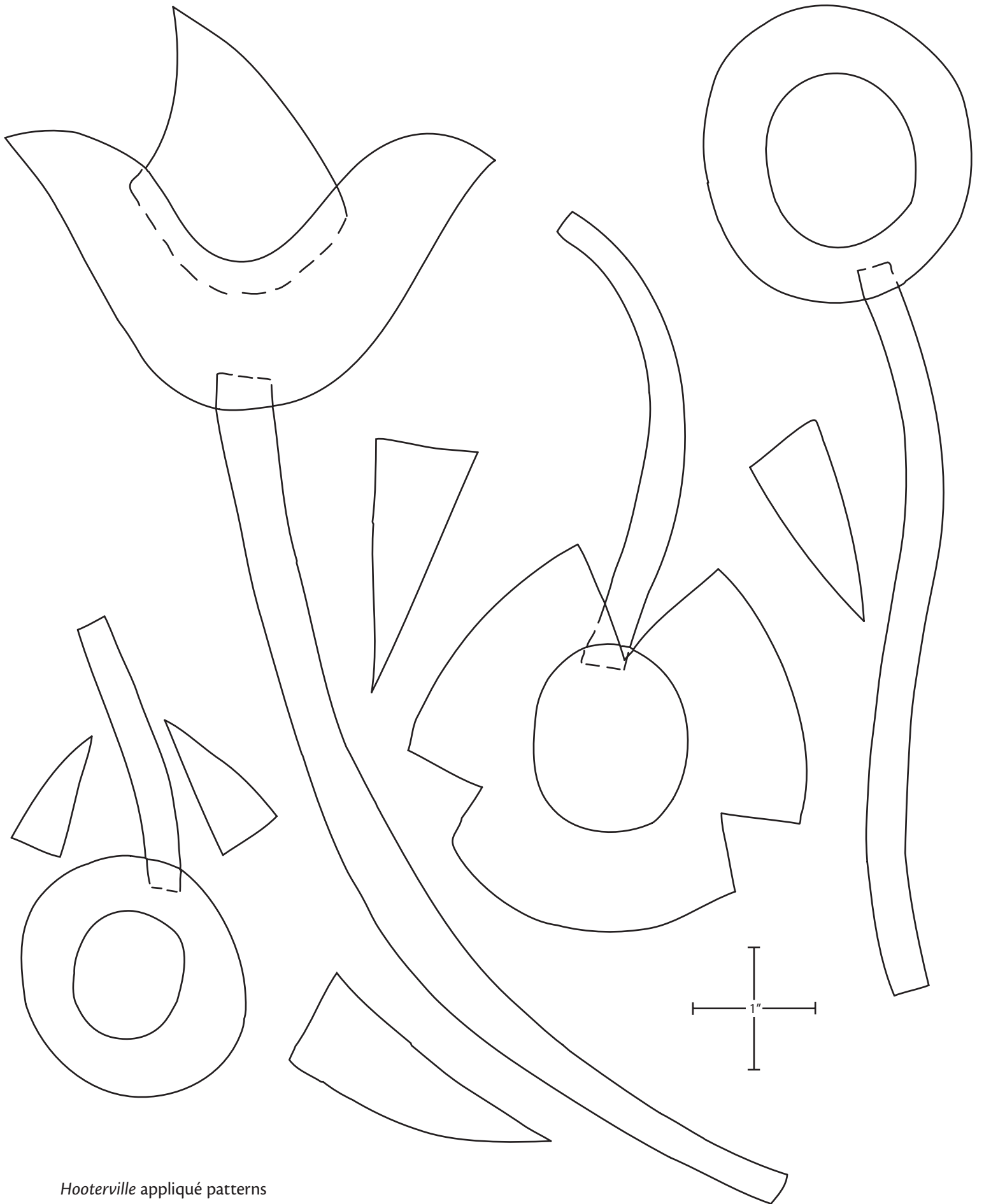

Hooterville appliqué patterns

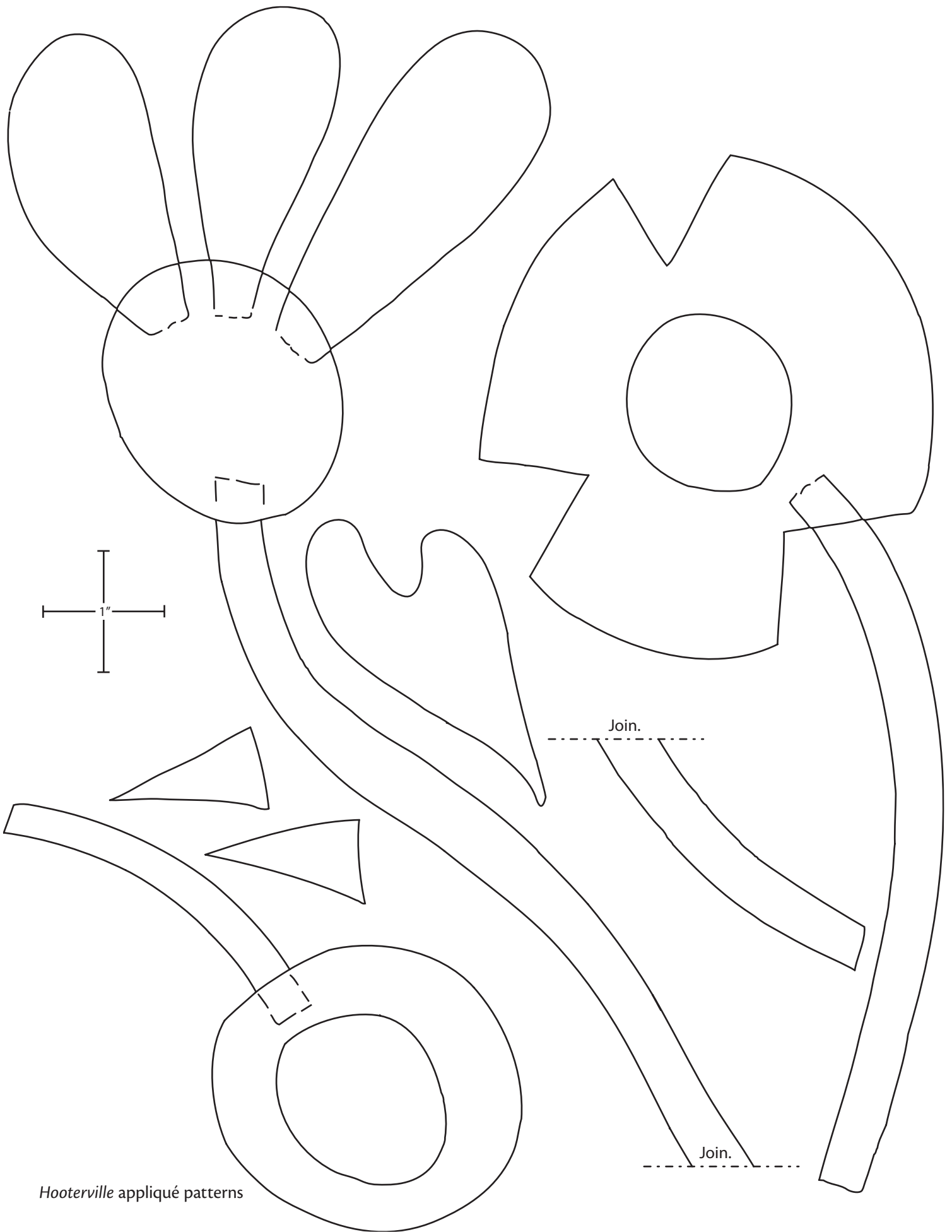

Hooterville appliqué patterns

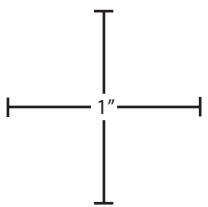
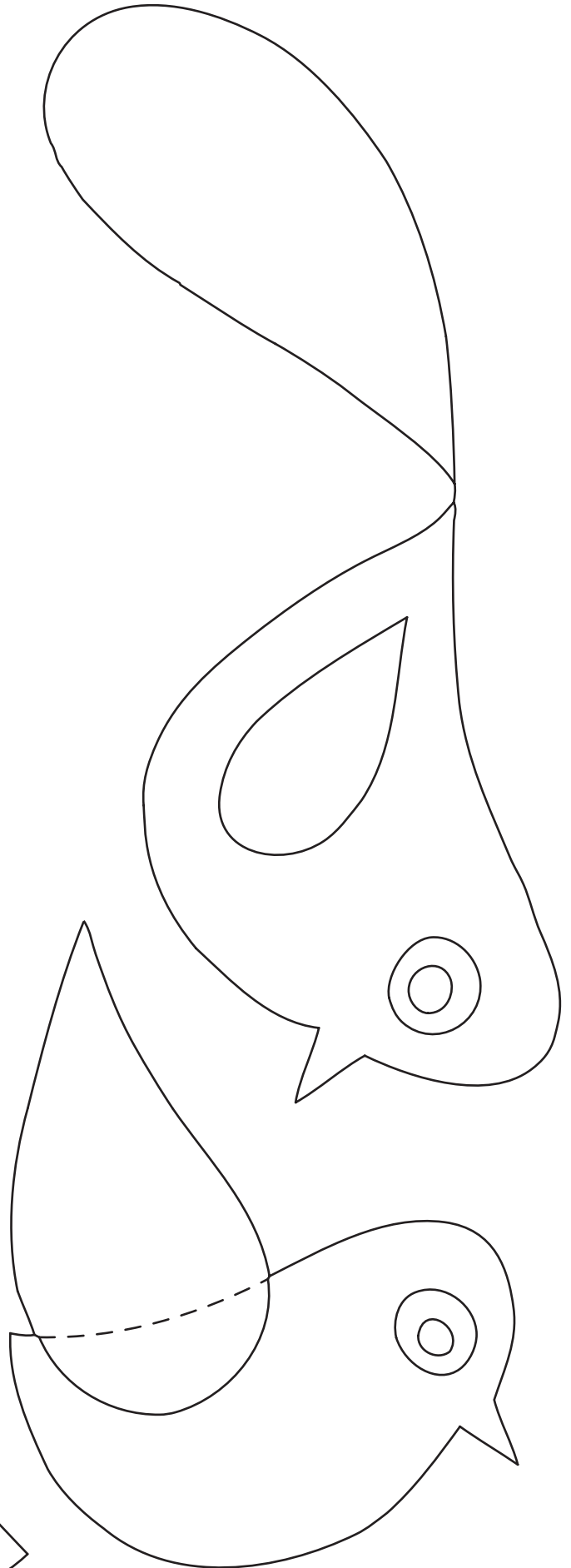
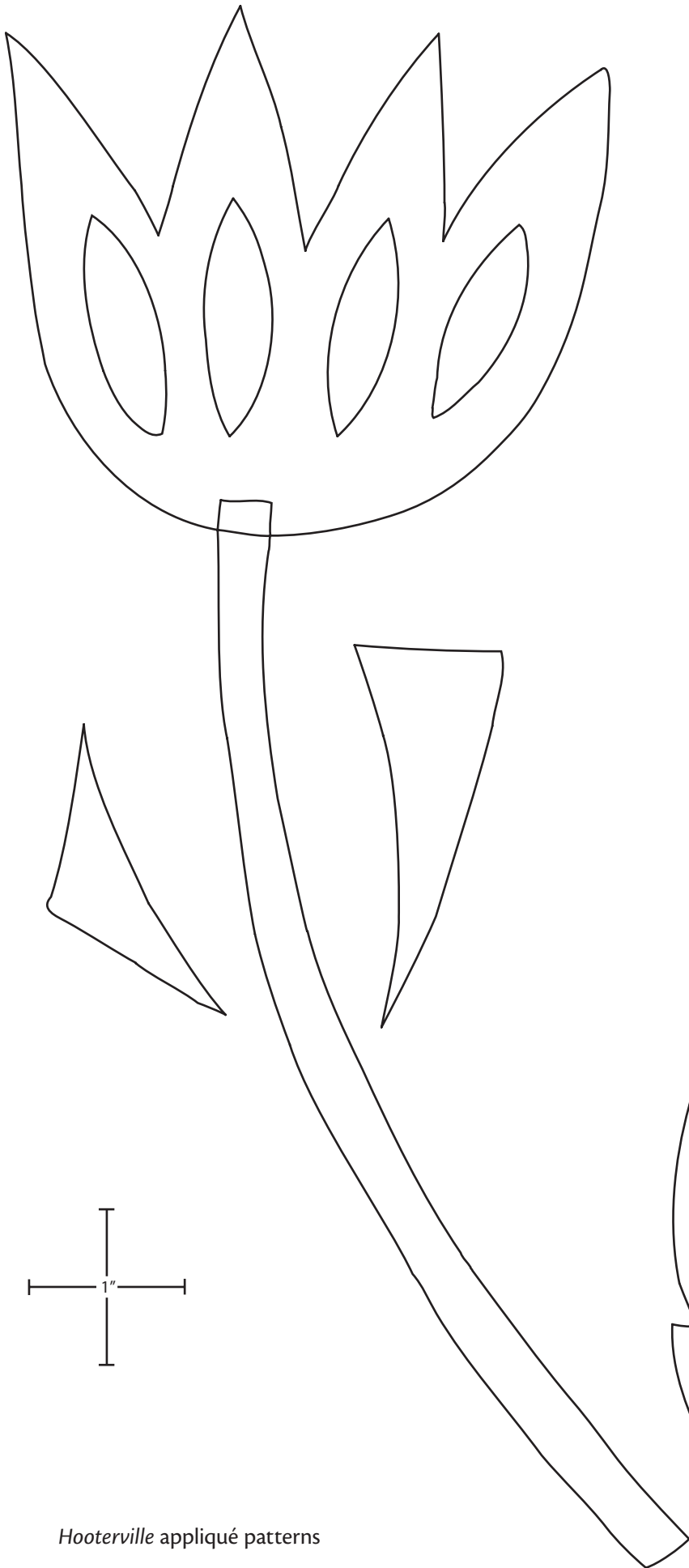

Hooterville appliqué patterns

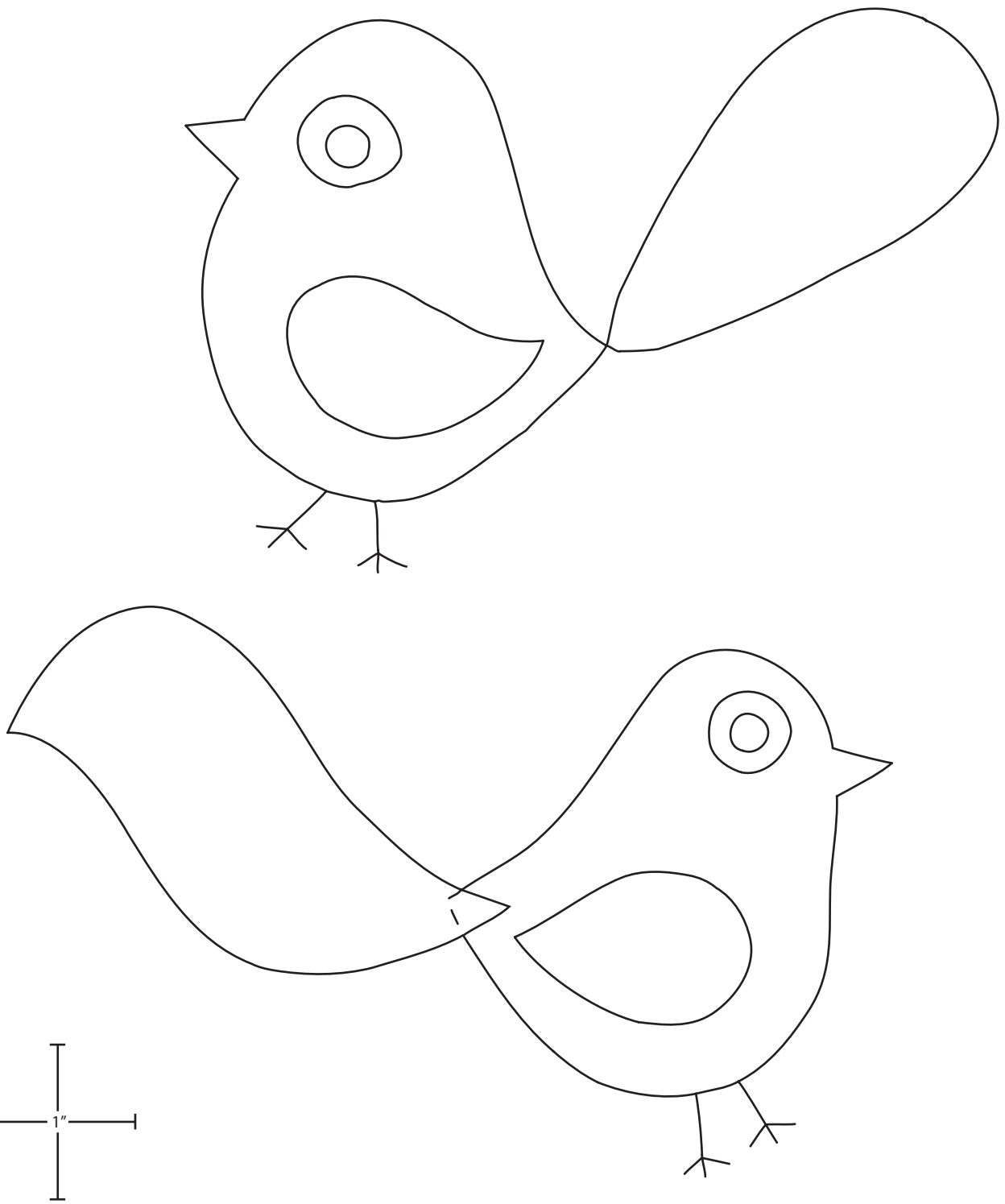

Hooterville appliqué patterns

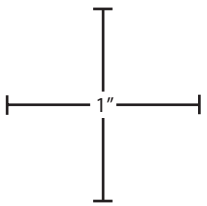
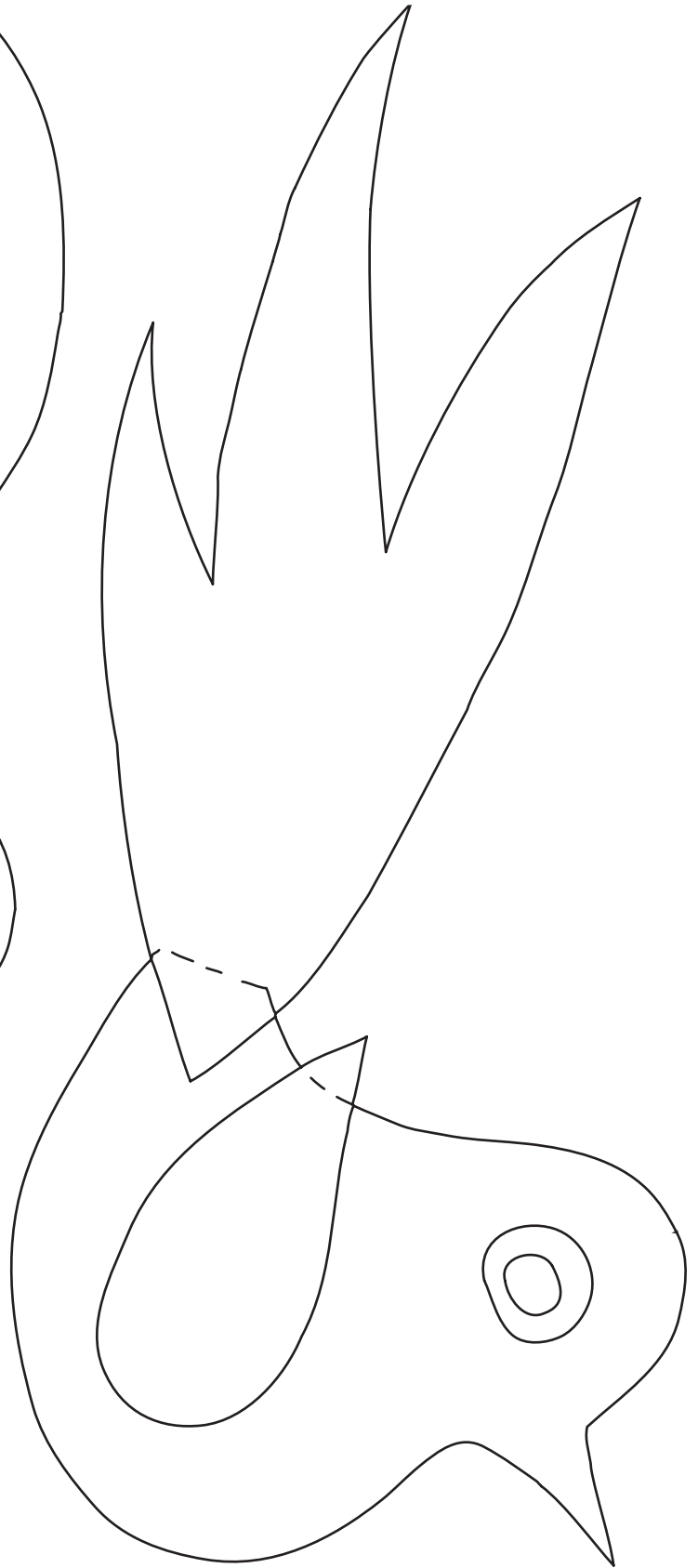
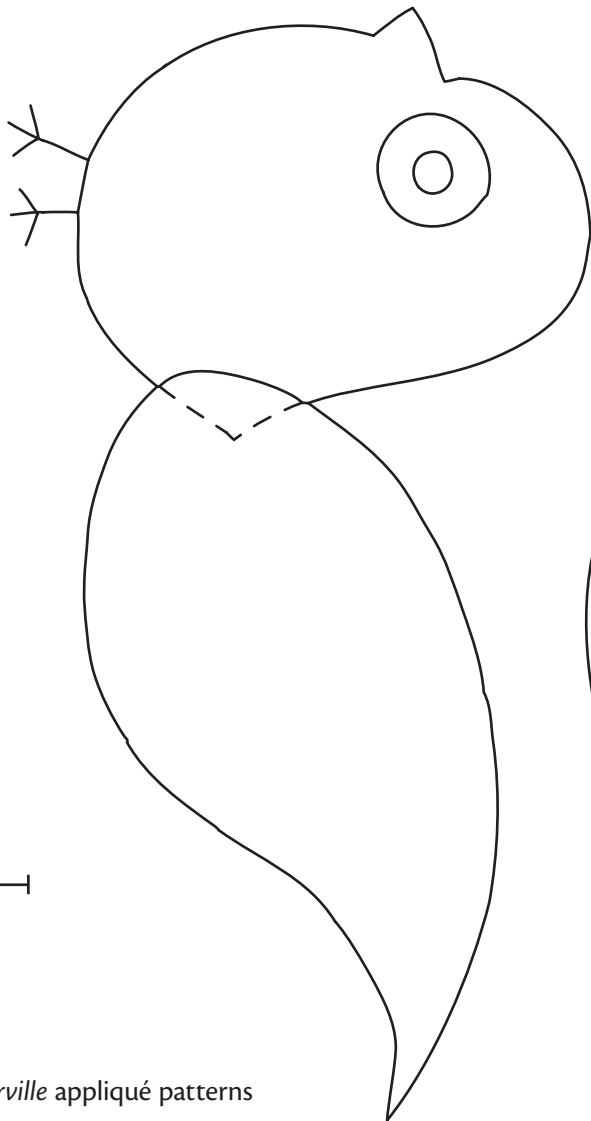
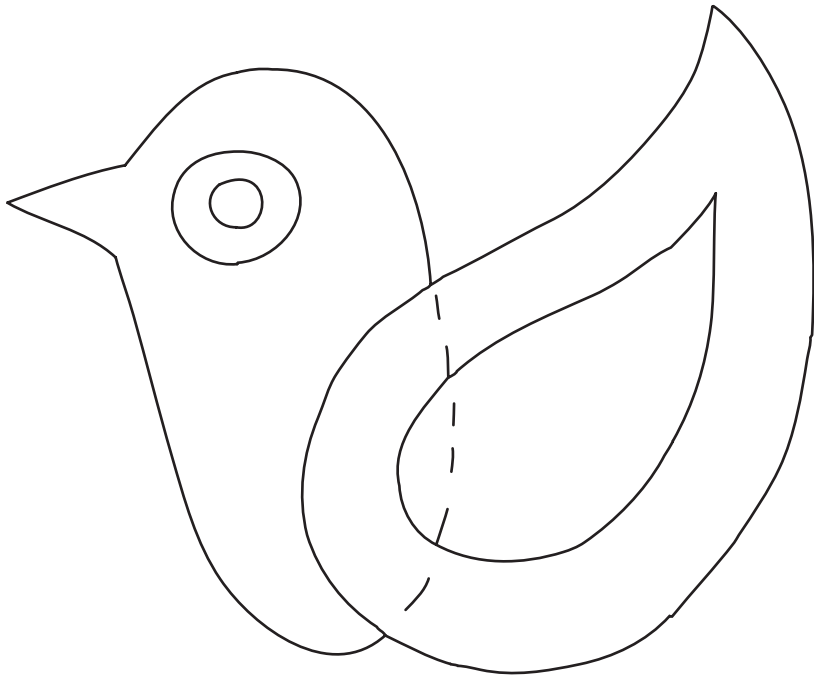

Hooterville appliqué patterns

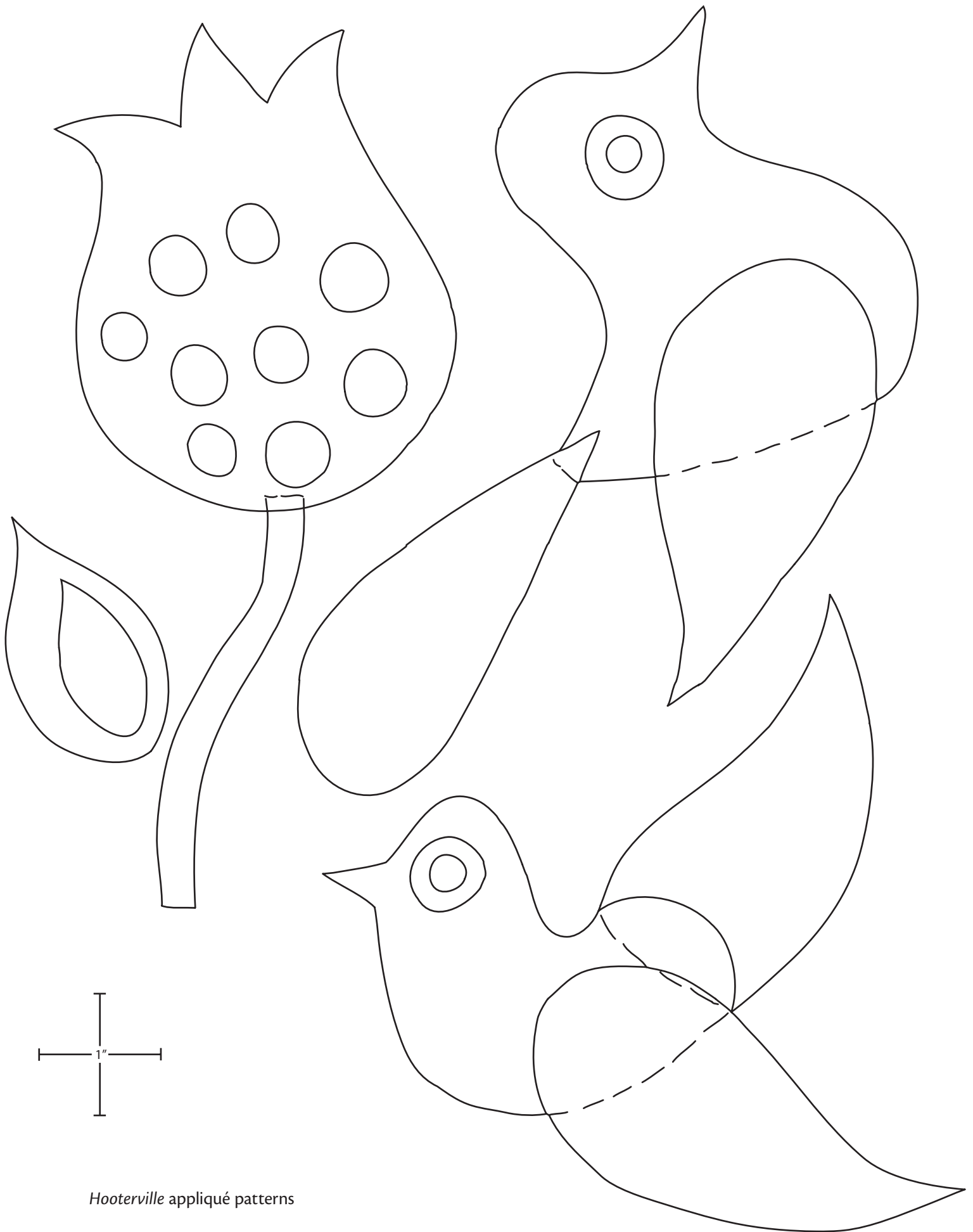

Hooterville appliqué patterns

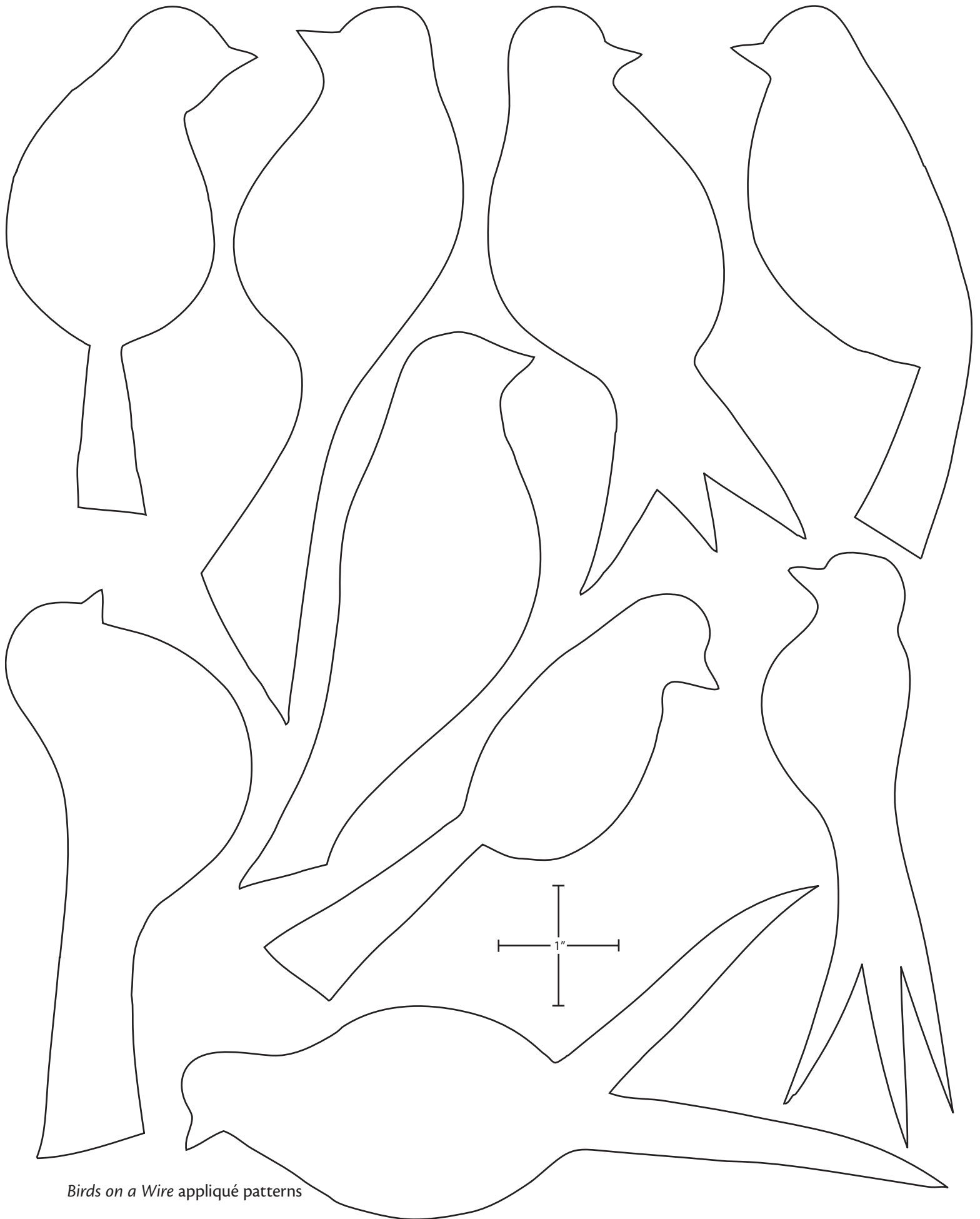

Birds on a Wire appliqué patterns

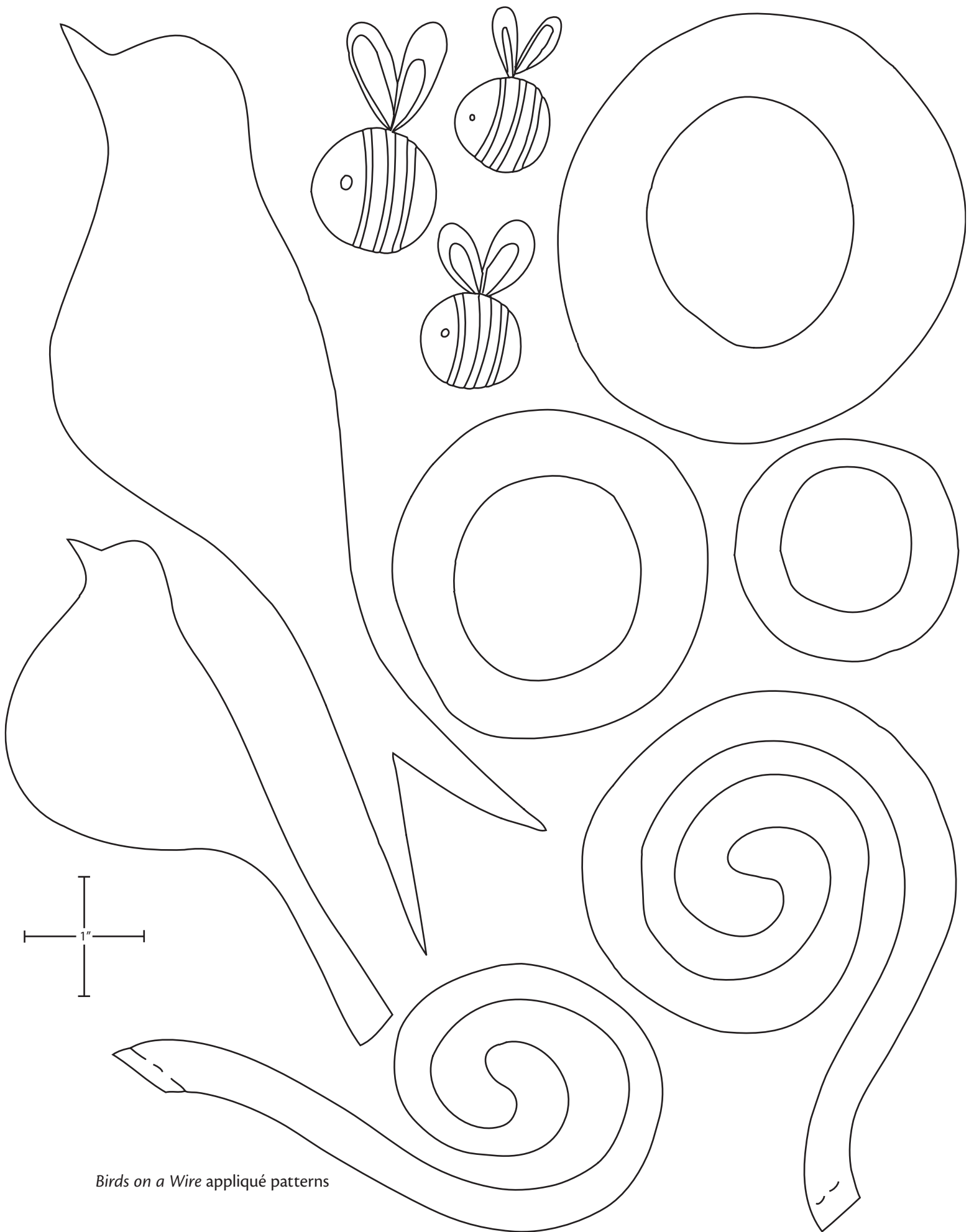

Birds on a Wire applique patterns

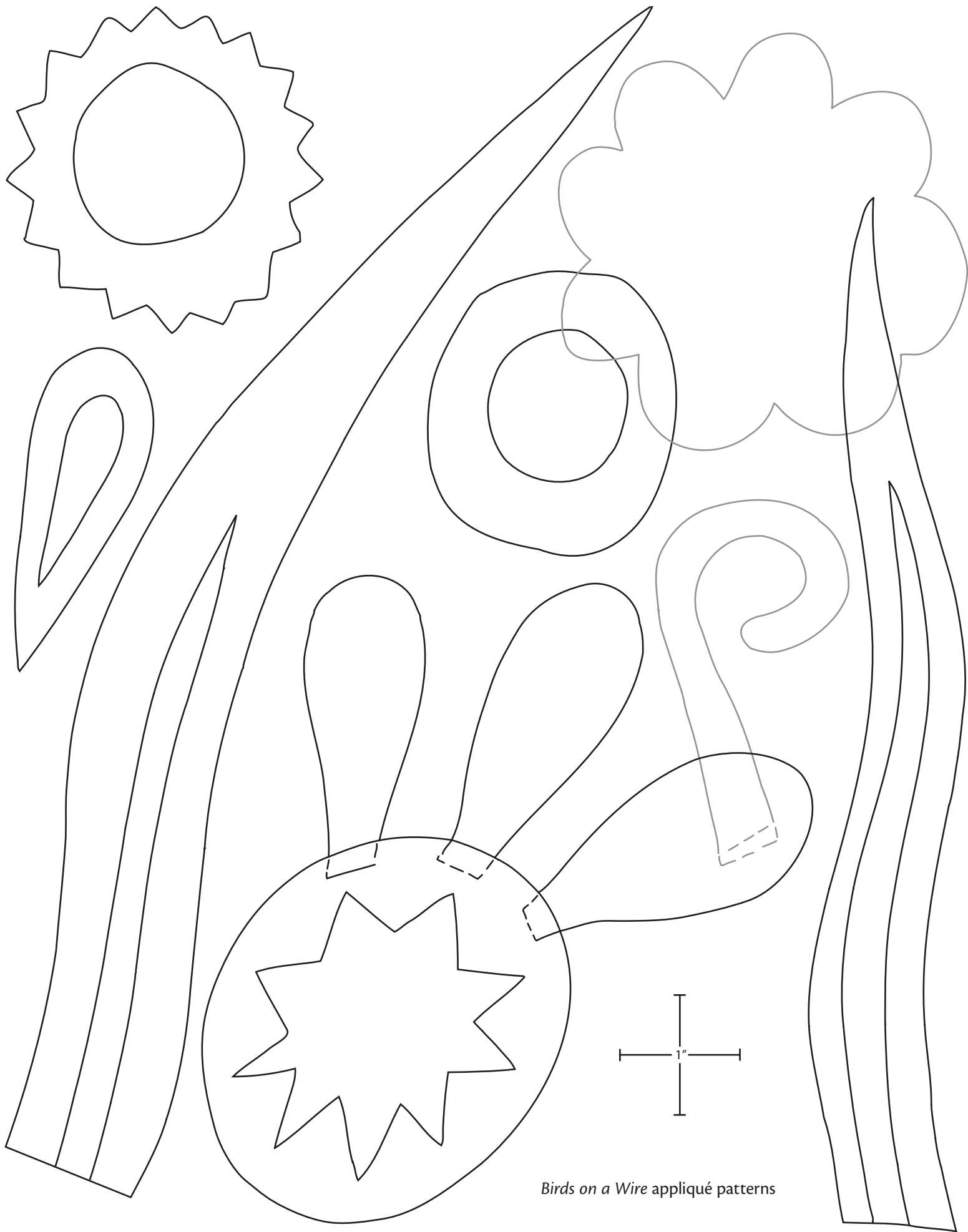

Birds on a Wire appliqué patterns

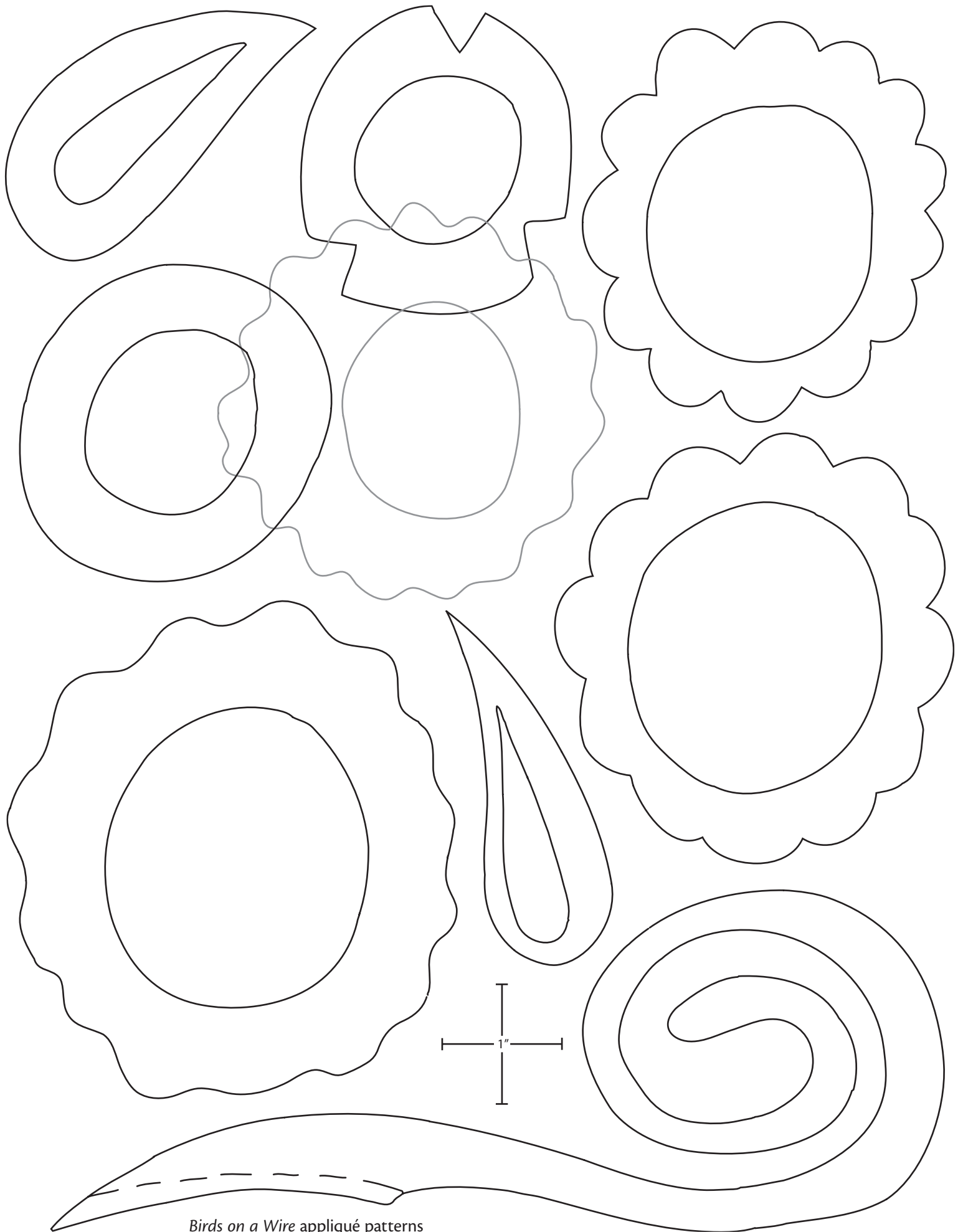

Birds on a Wire appliqué patterns

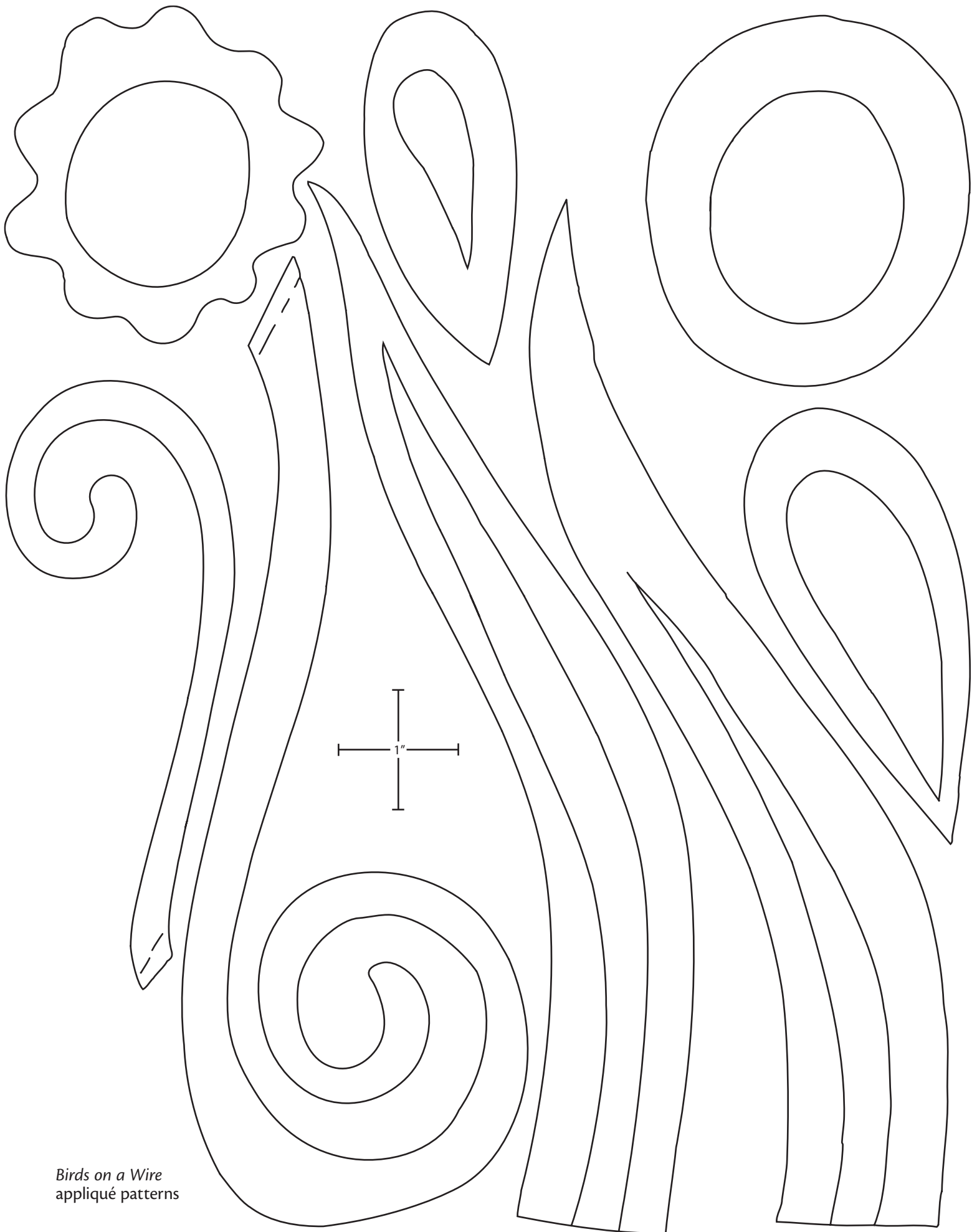

Birds on a Wire
appliqué patterns

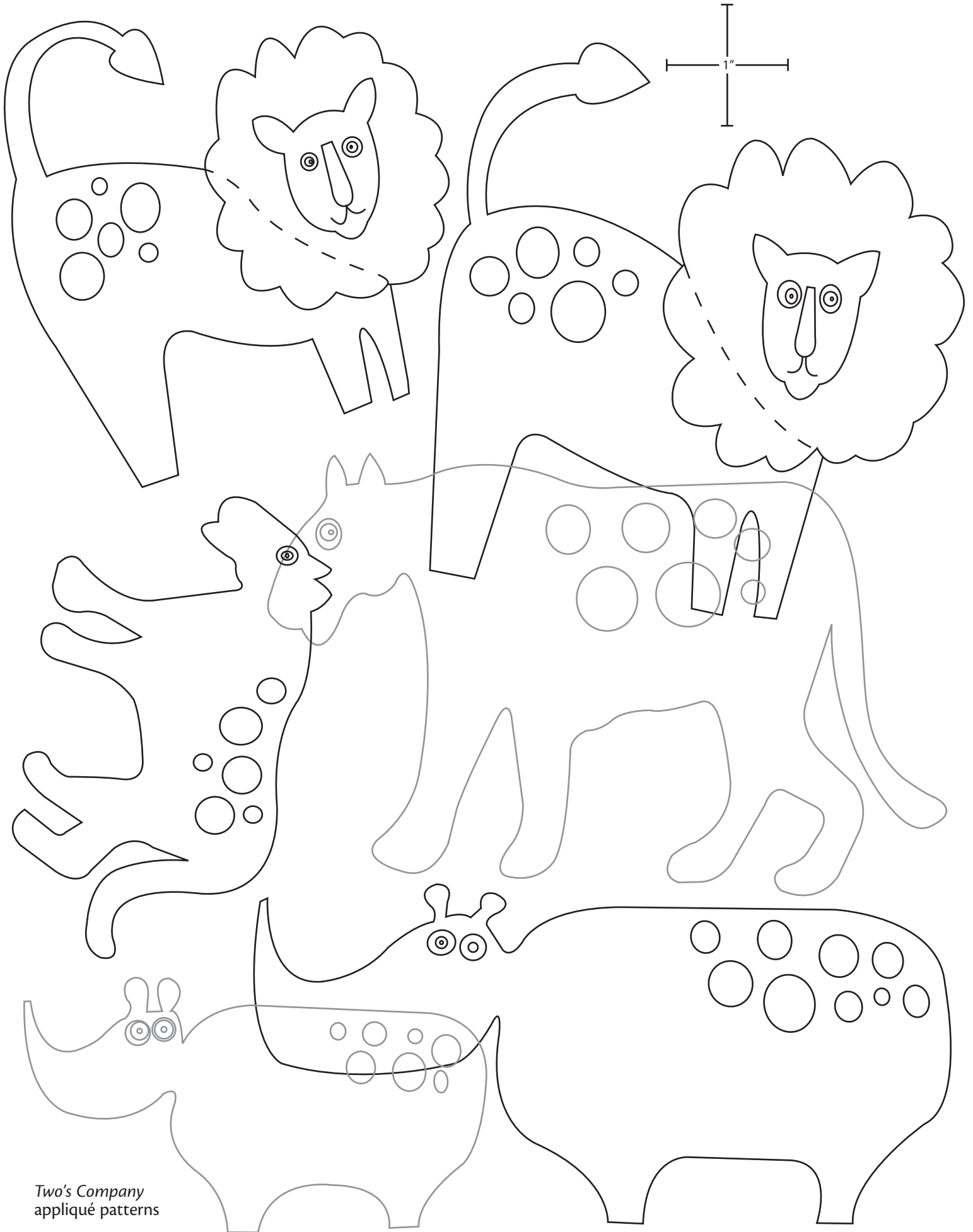

Two's Company
appliqué patterns



Two's Company appliqué patterns

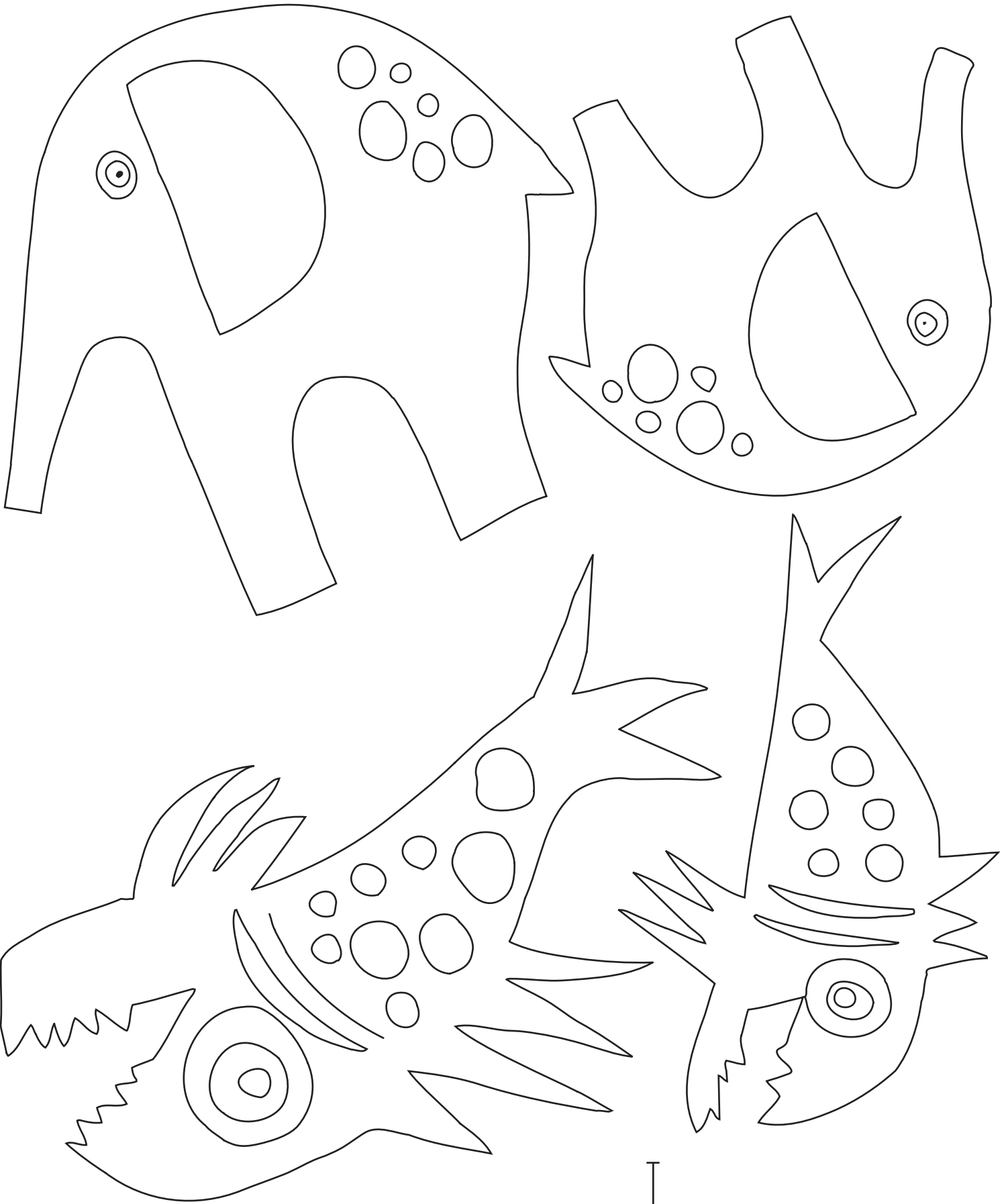

Two's Company appliqué patterns

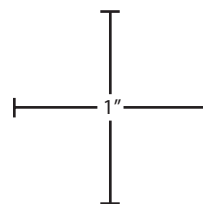



Two's Company
appliqué patterns

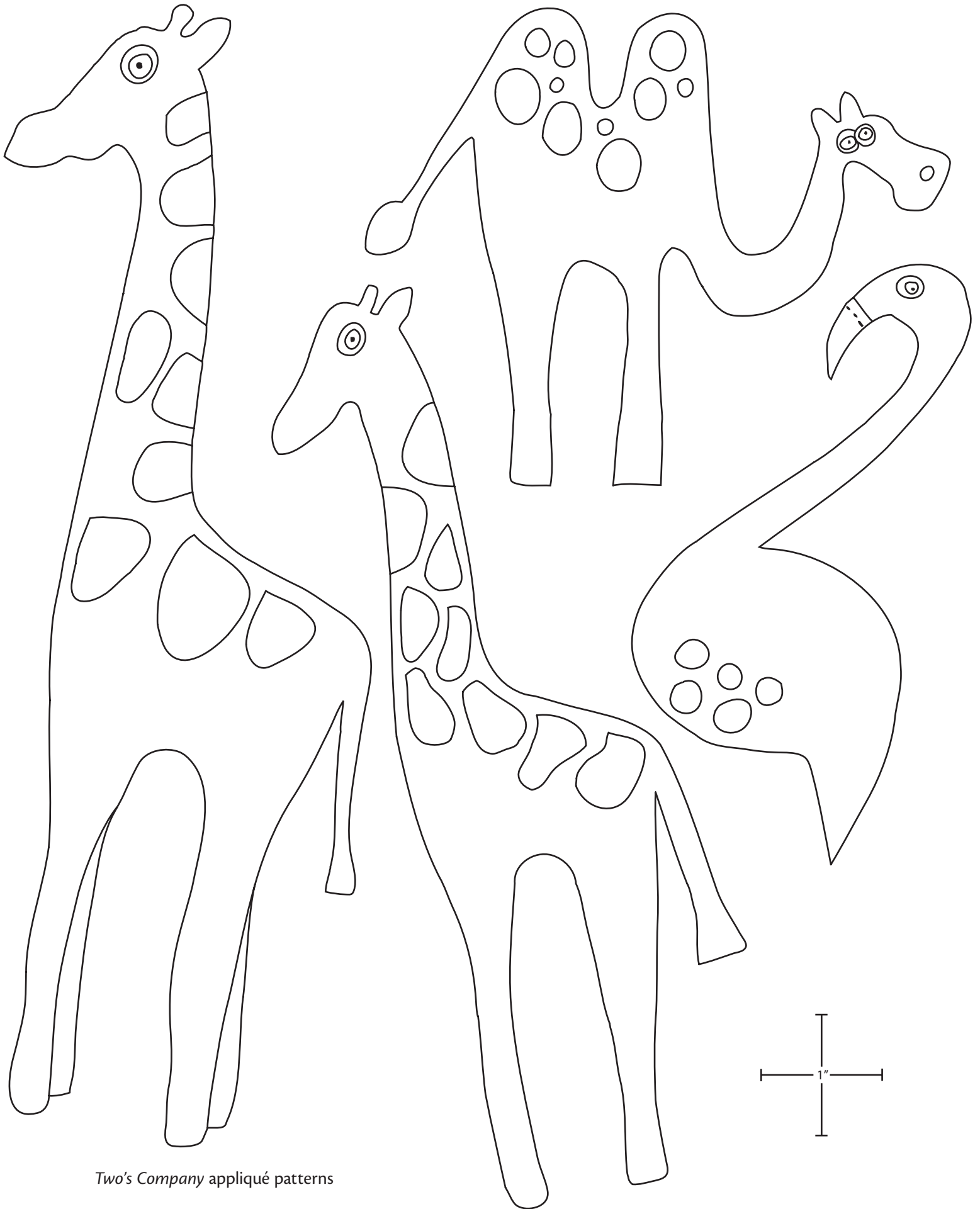

Two's Company appliqué patterns

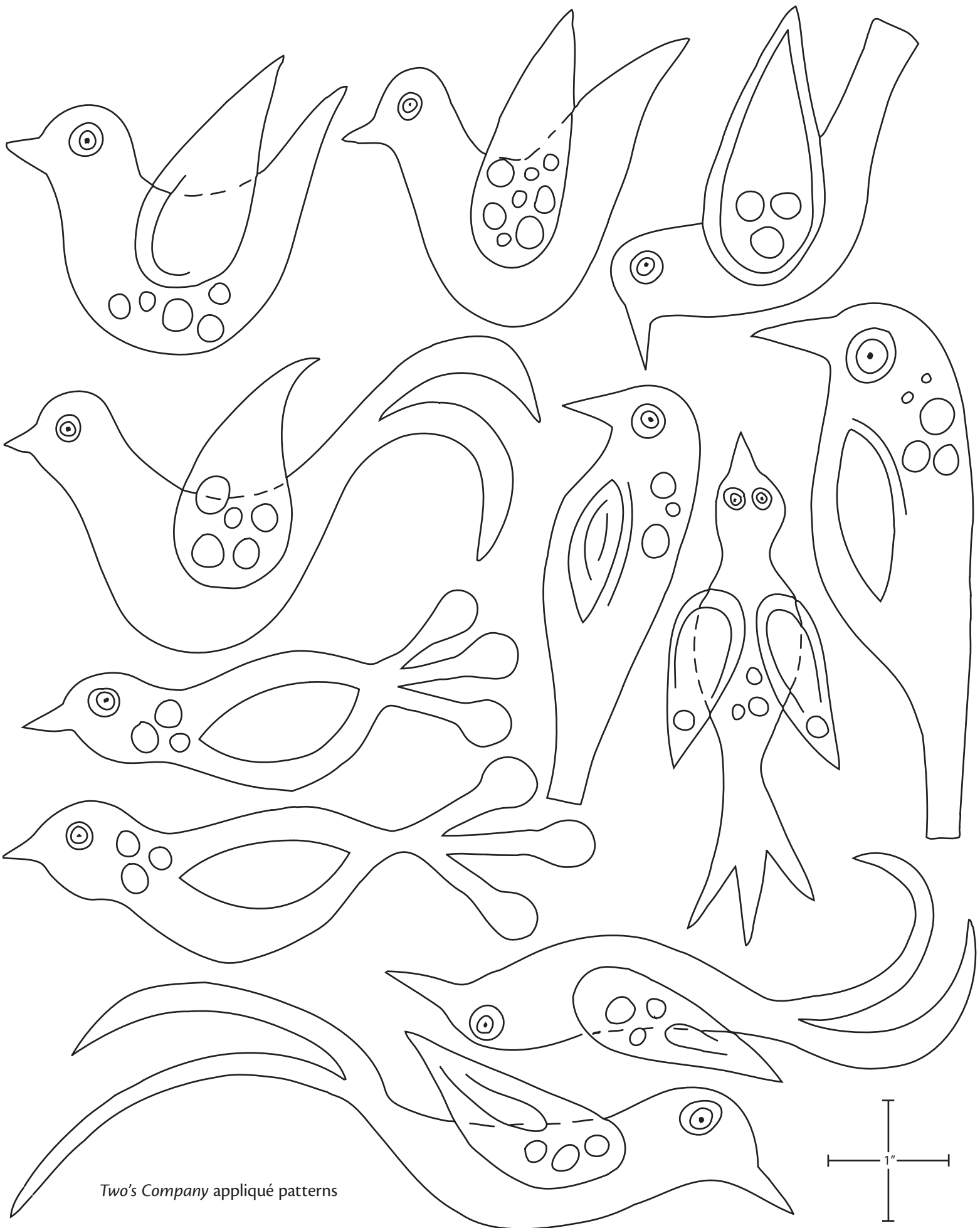

Two's Company appliqué patterns

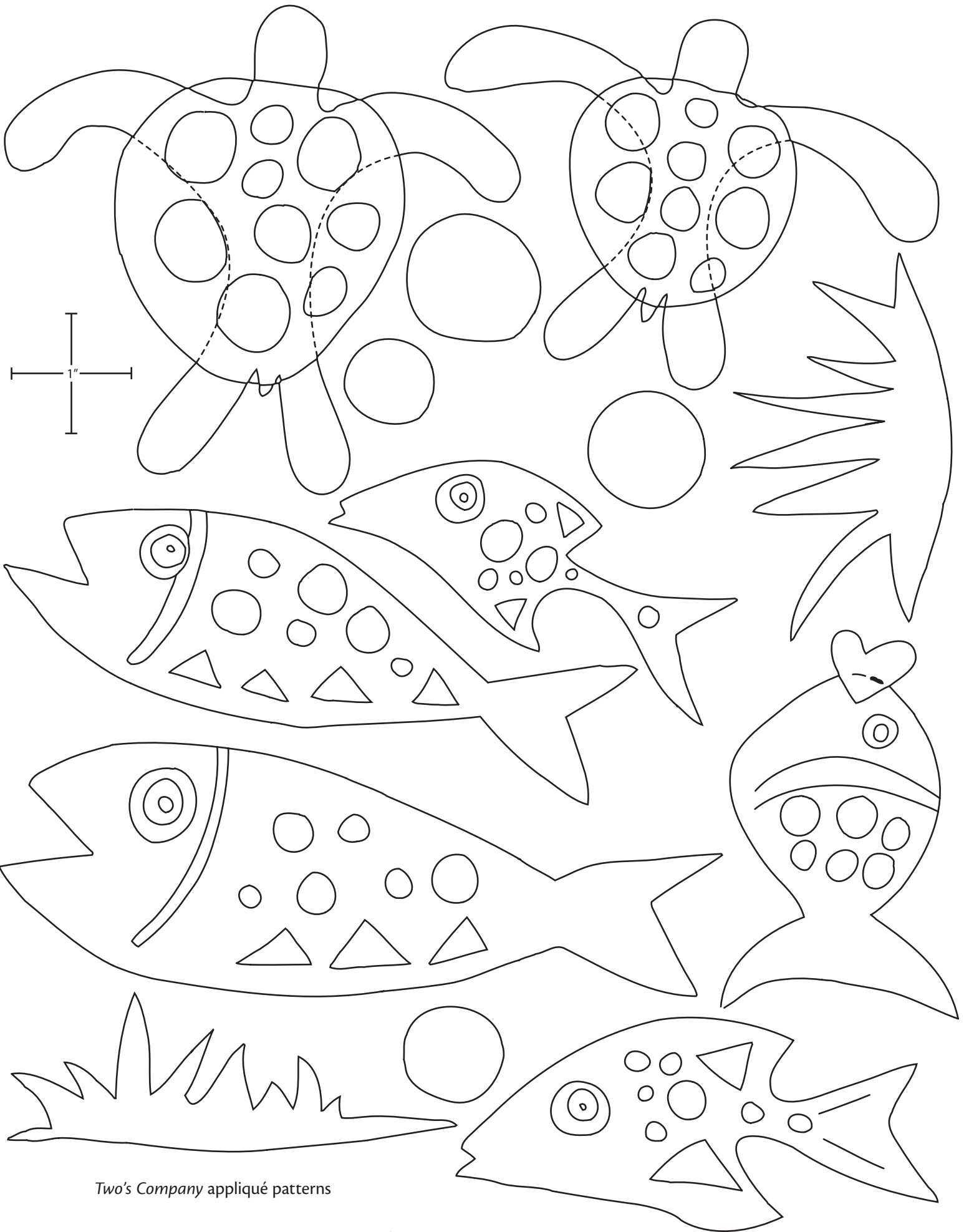

Two's Company appliqué patterns

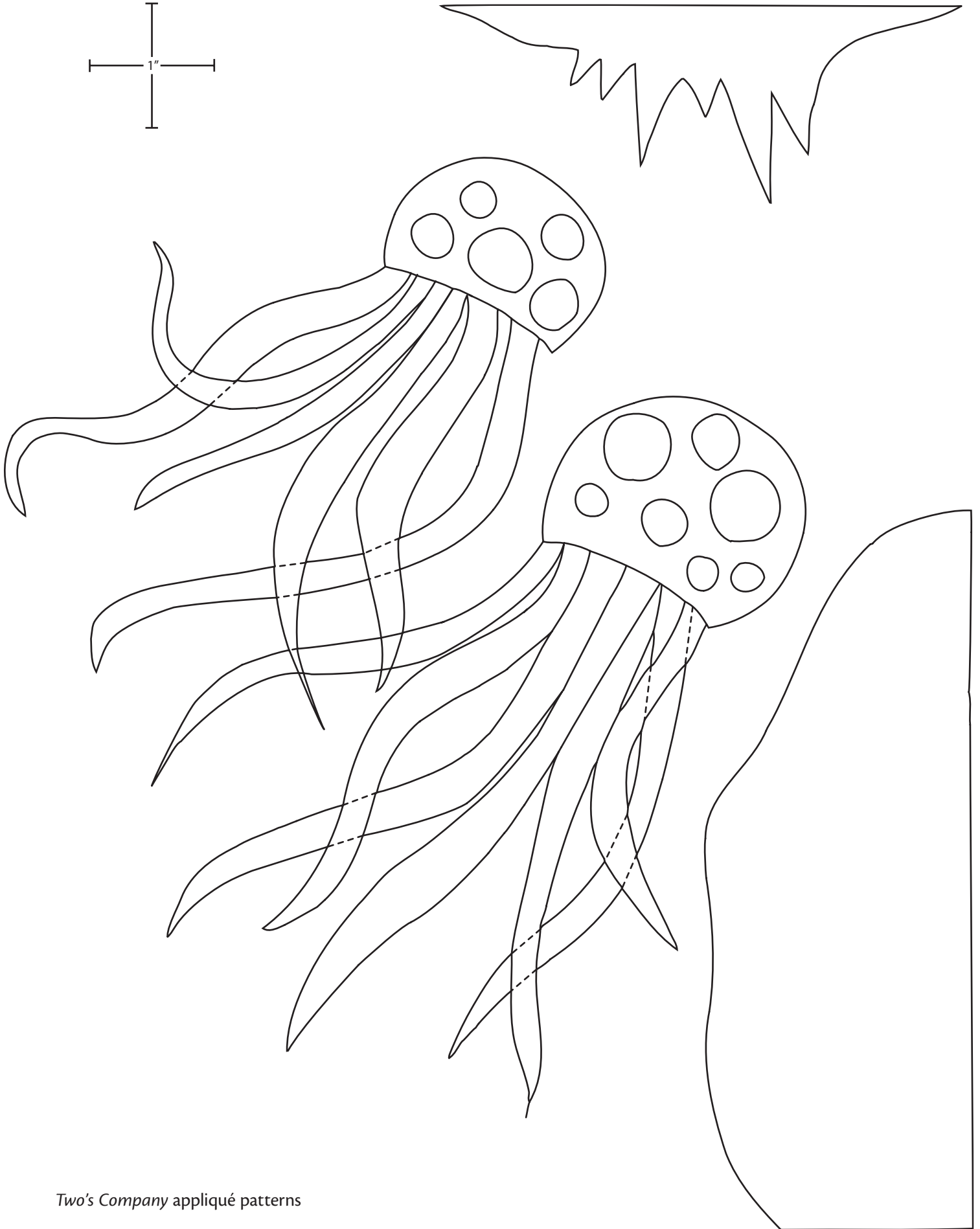
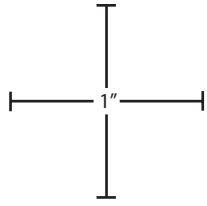

Two's Company appliqué patterns

L=Light green
D=Dark green

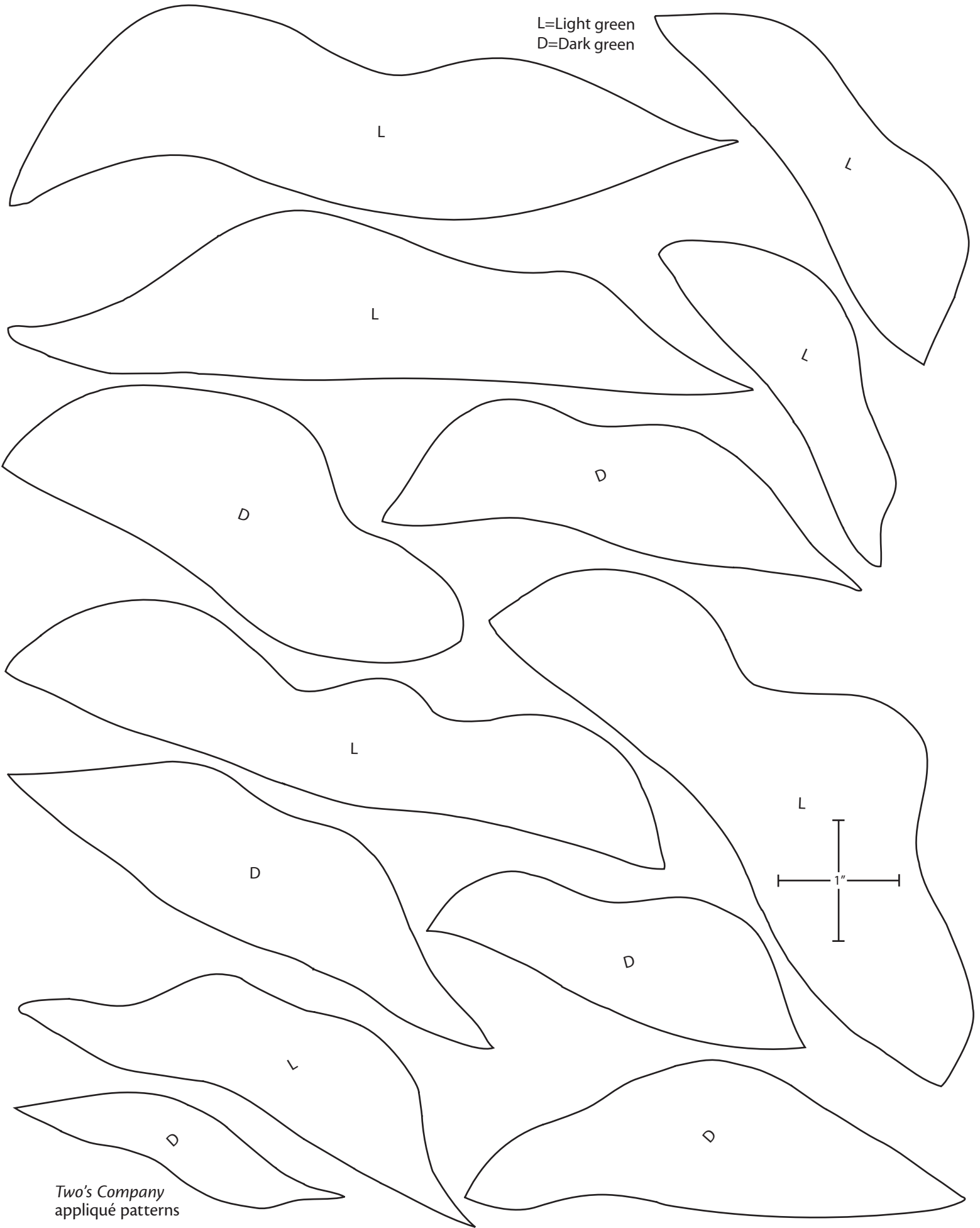

Two's Company
appliqué patterns

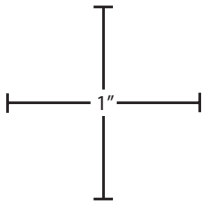

Cut to create branches.

Join.

Join.

Tree

Two's Company appliqué patterns

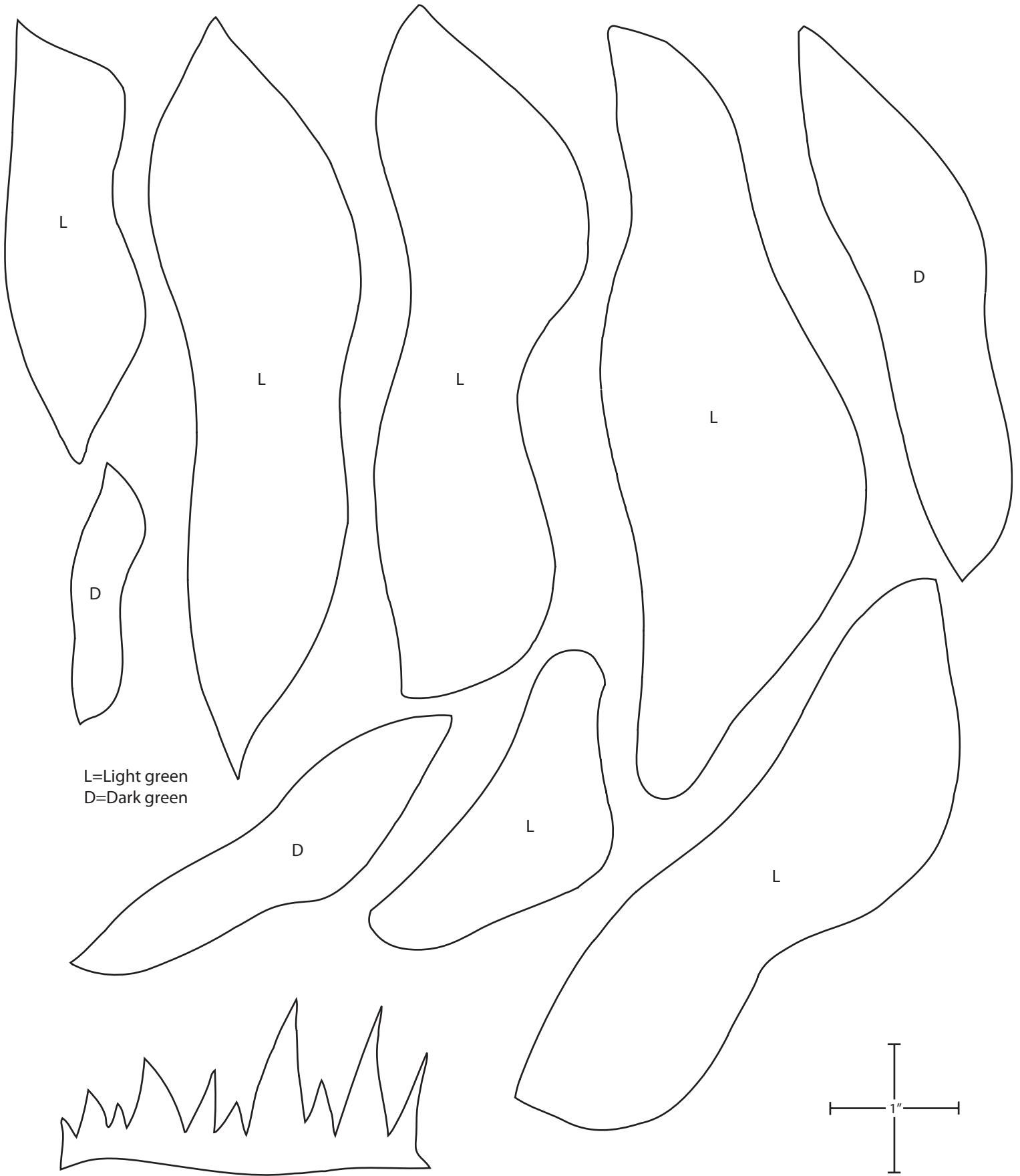

L=Light green
D=Dark green

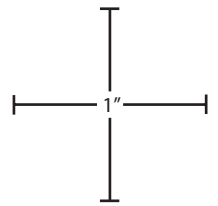

Two's Company appliqué patterns

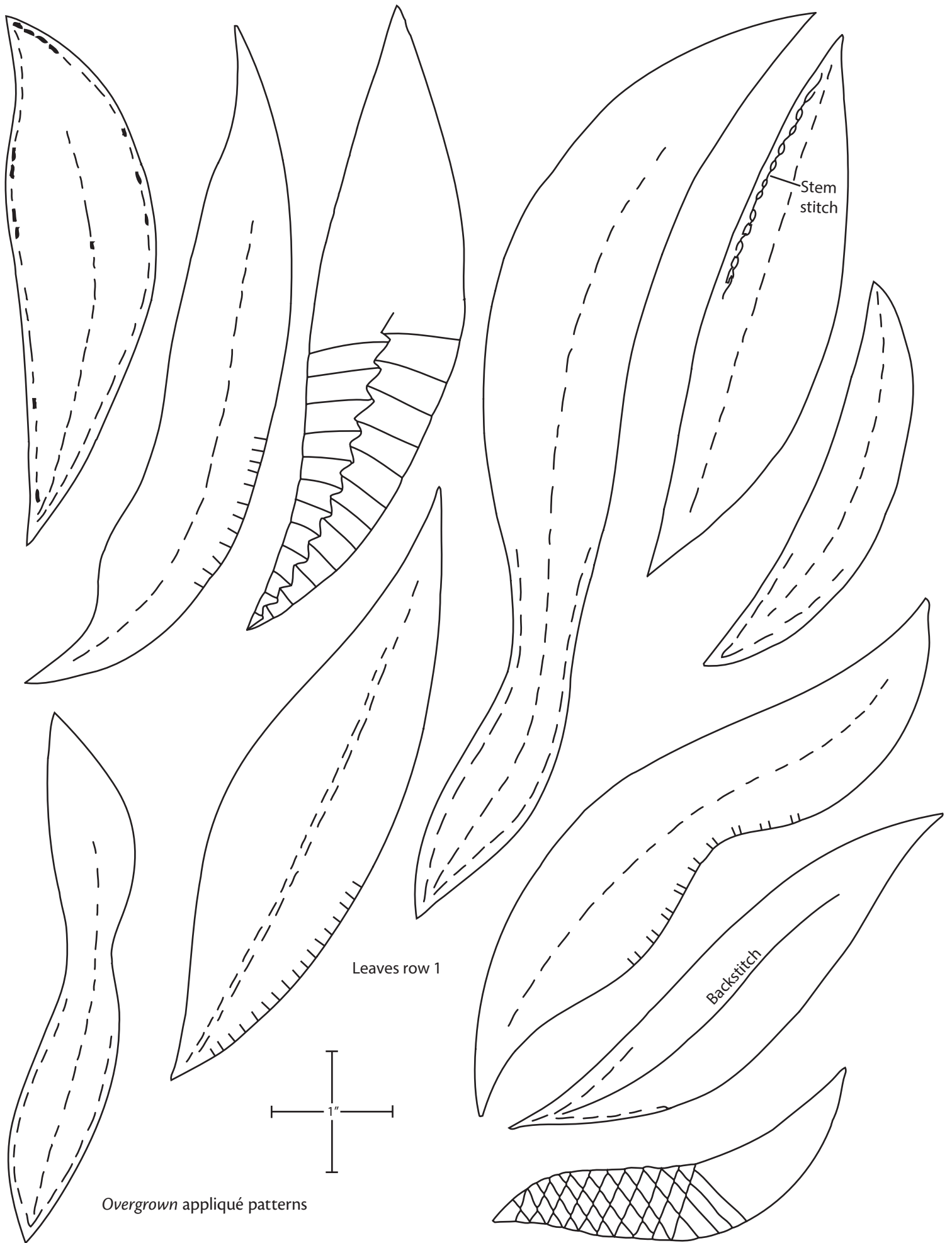

Stem
stitch

Leaves row 1

Backstitch

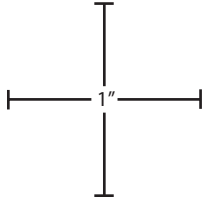

Overgrown appliqué patterns

Leaves row 2

Herringbone

Whipstitch

Backstitch

Backstitch

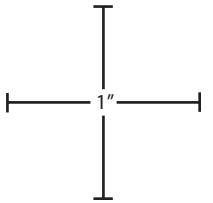

Overgrown appliqué patterns

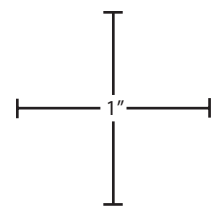
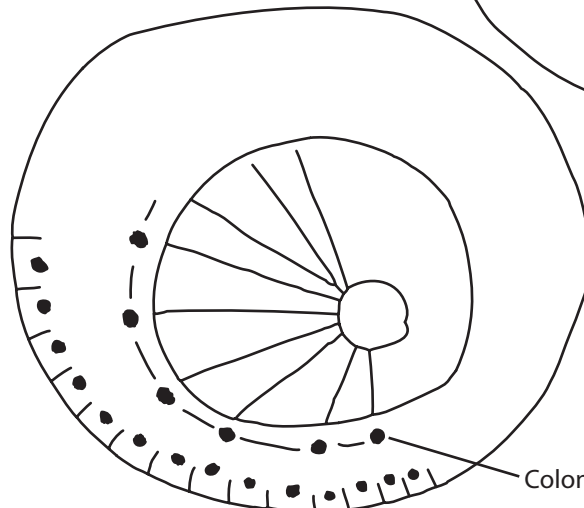
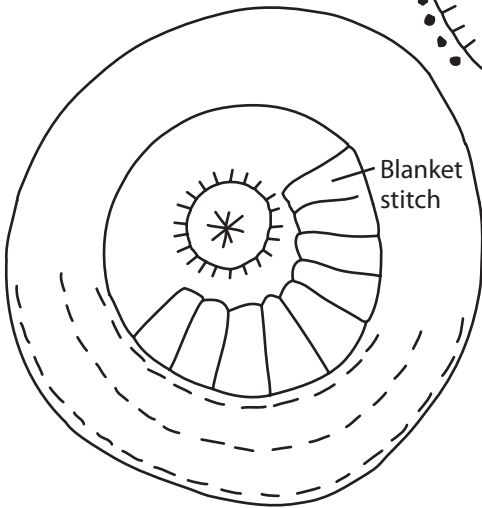
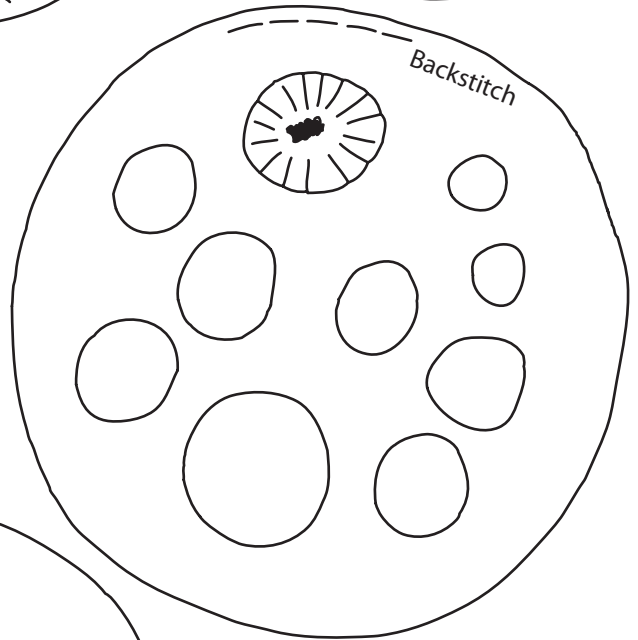
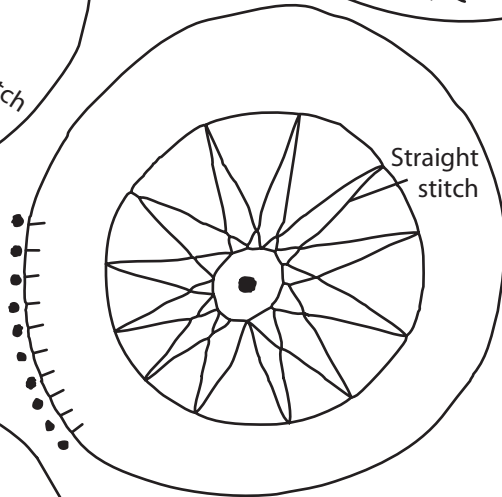
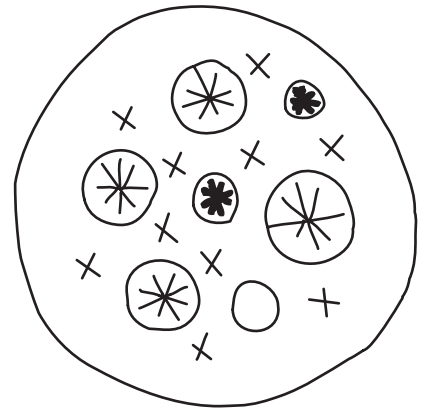
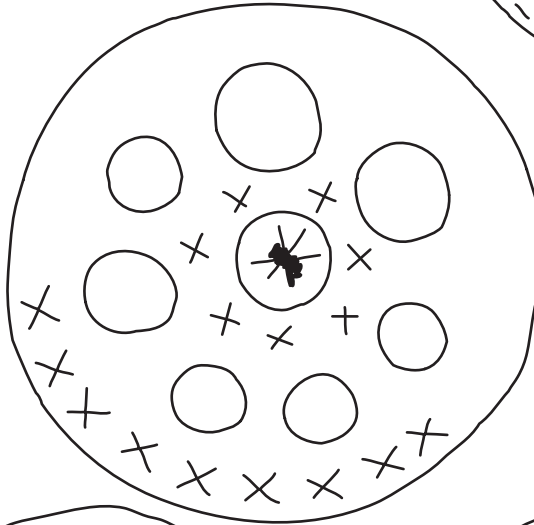
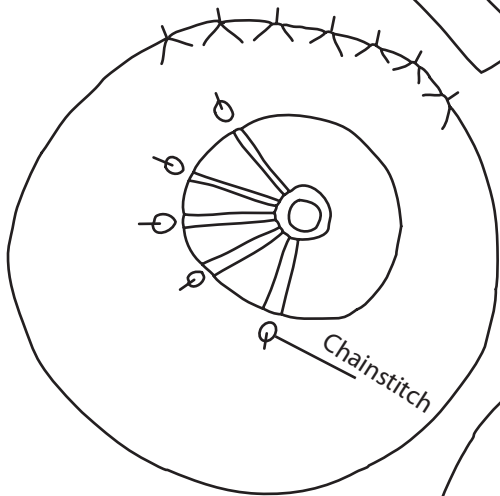
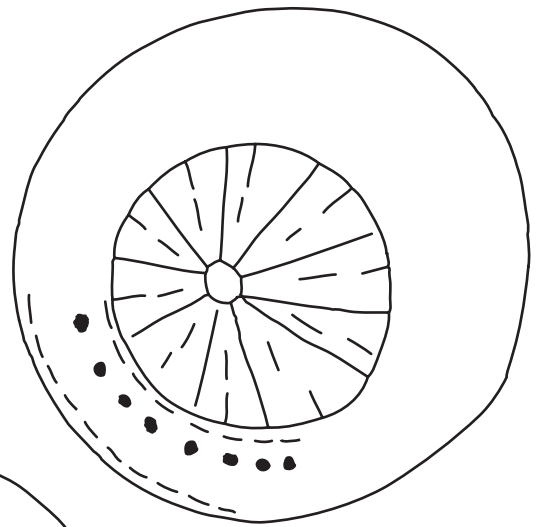
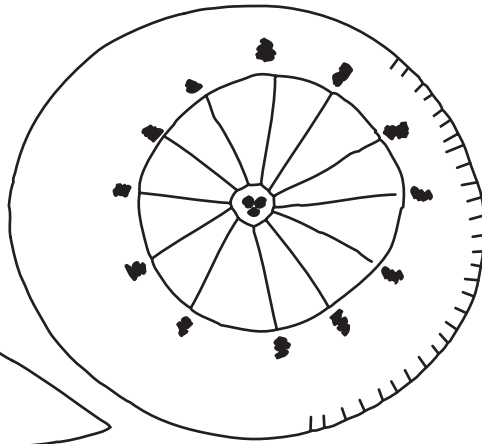
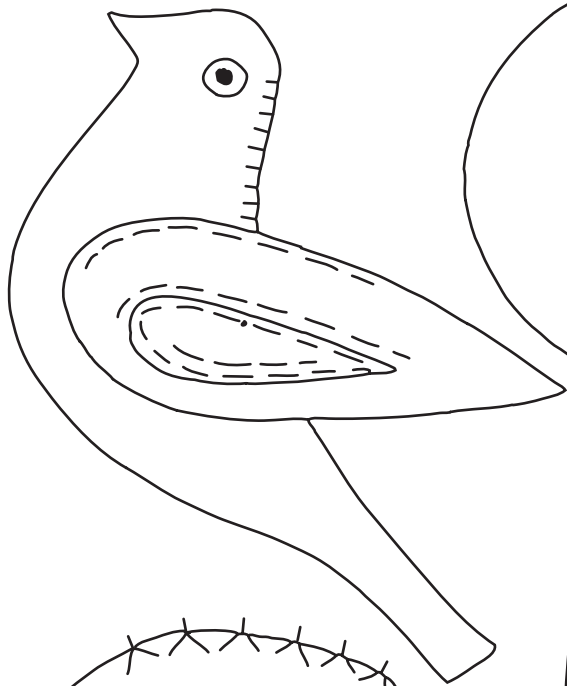

Overgrown appliqué patterns

Colonial knots

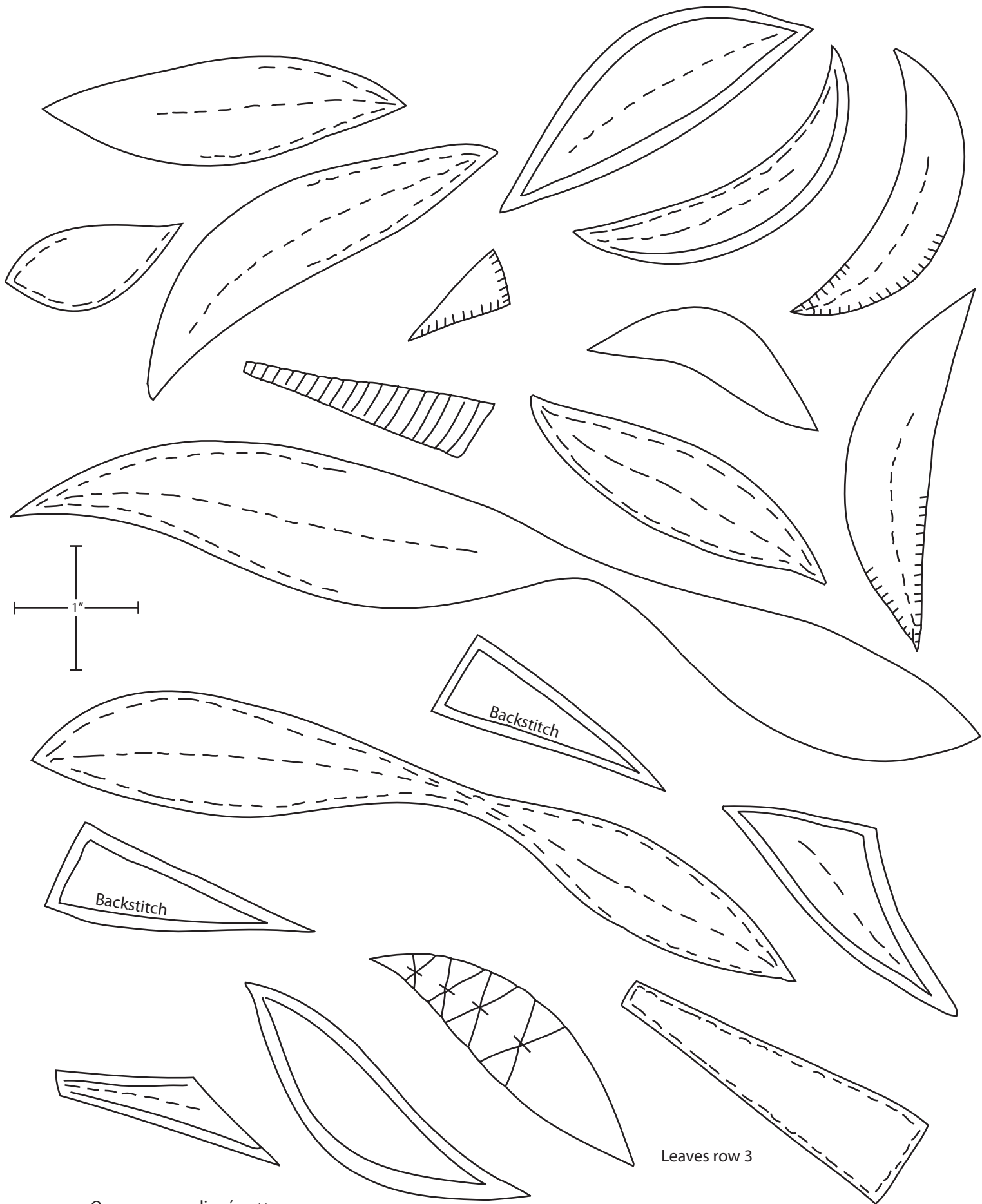

Overgrown appliqué patterns

Leaves row 3

Leaves row 4

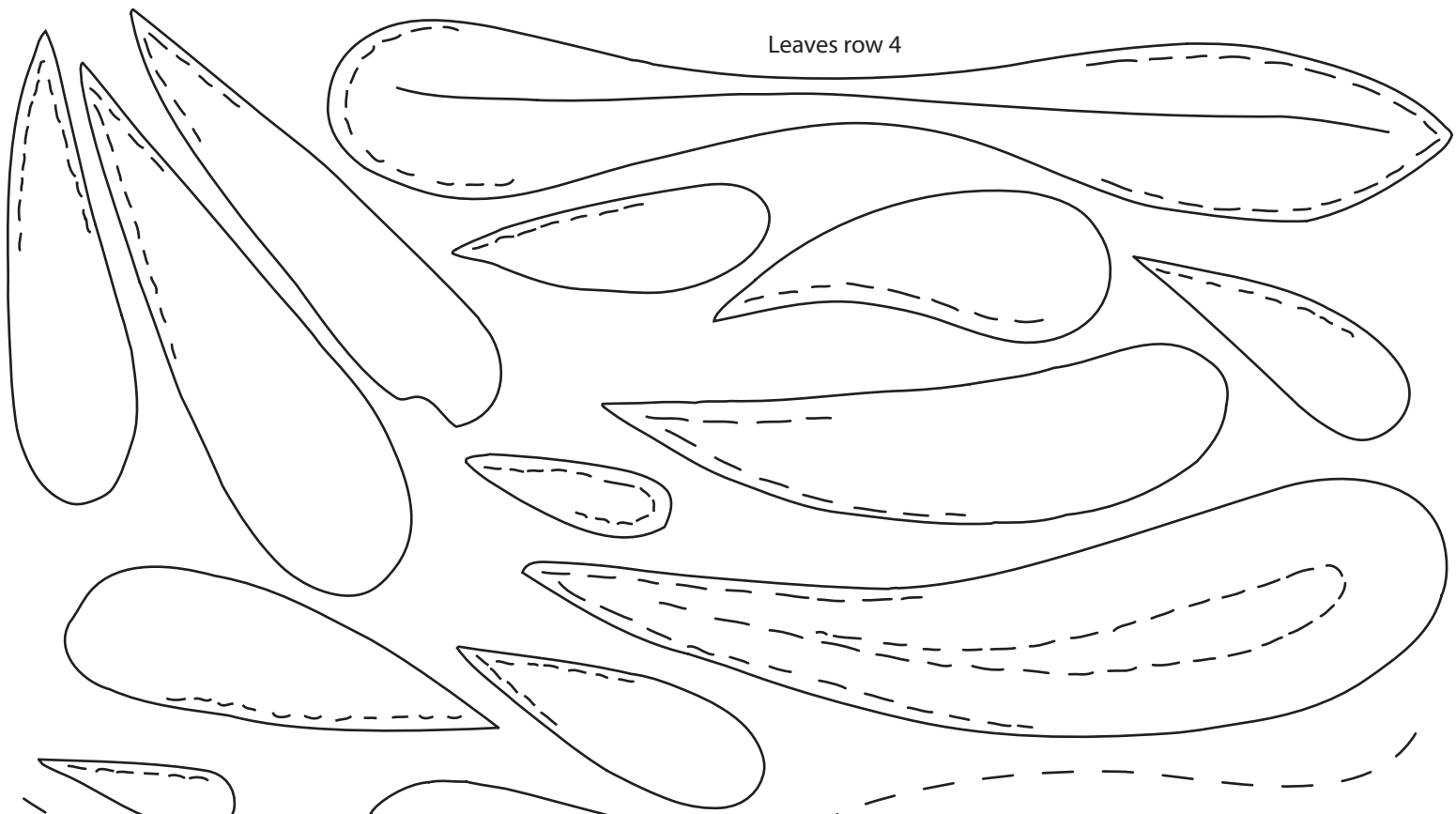

Leaves row 5

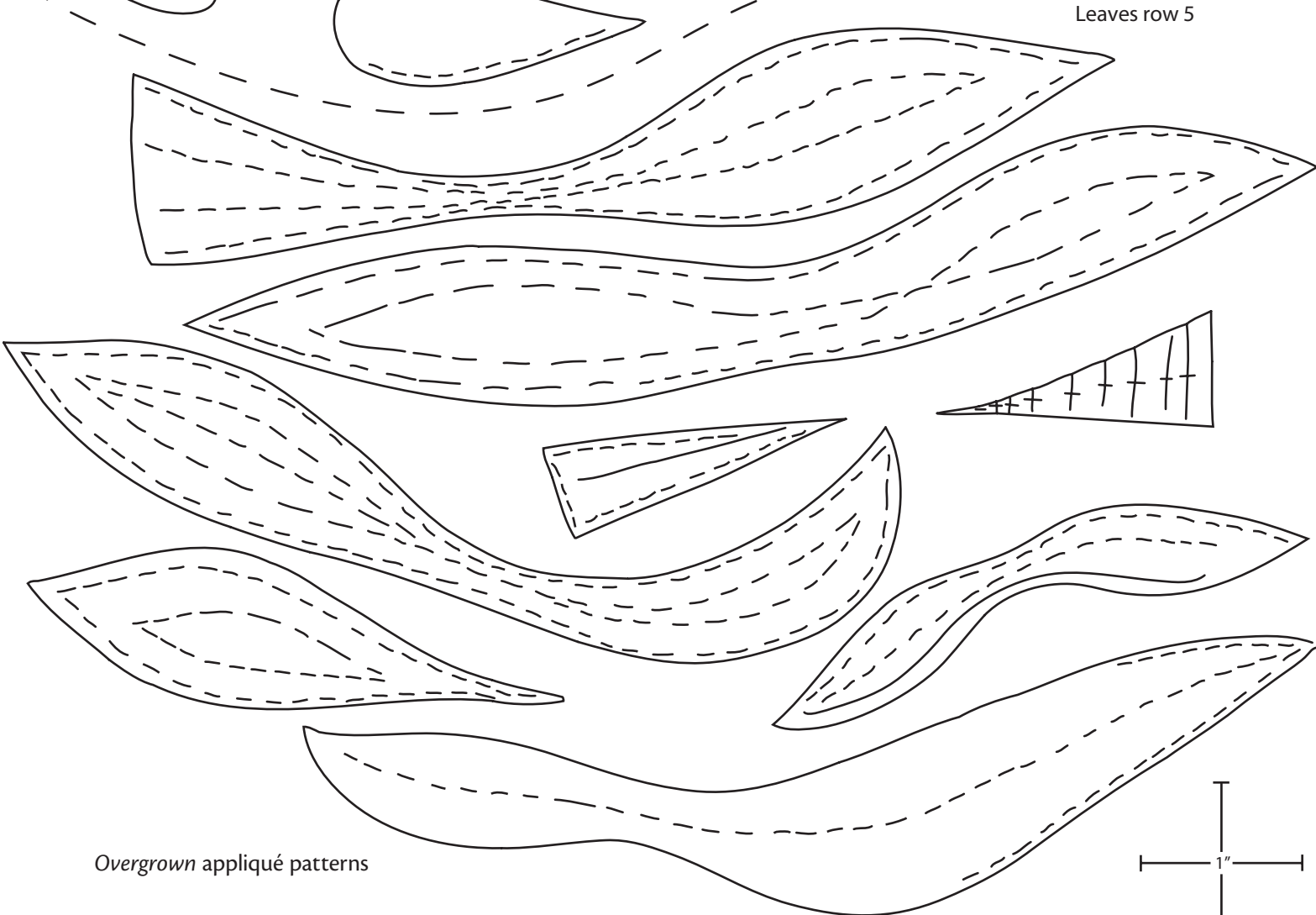

Overgrown appliqué patterns

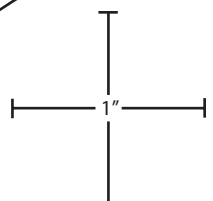

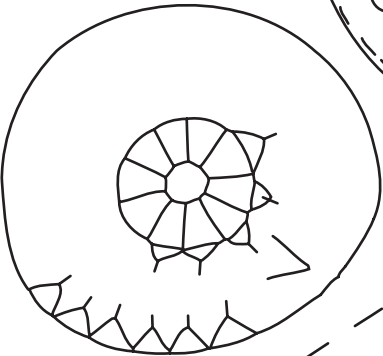
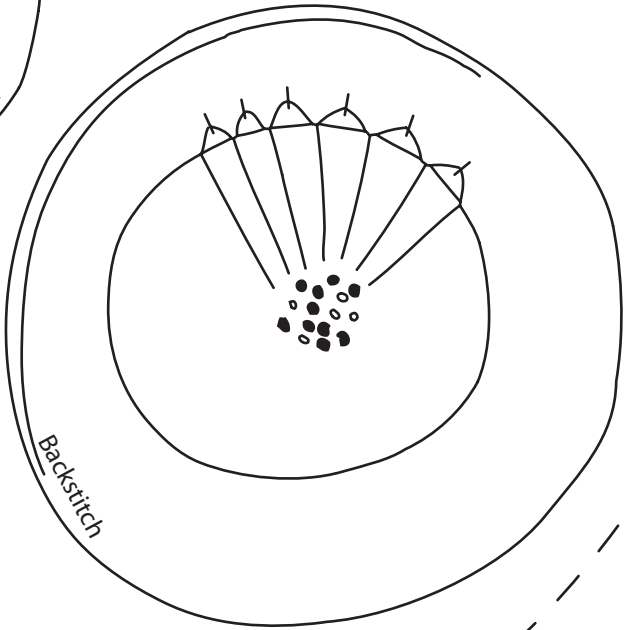
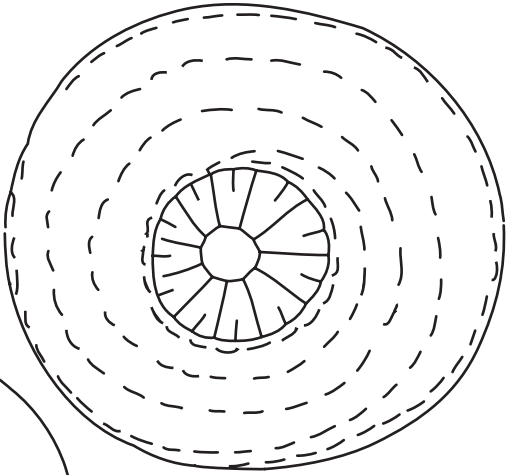
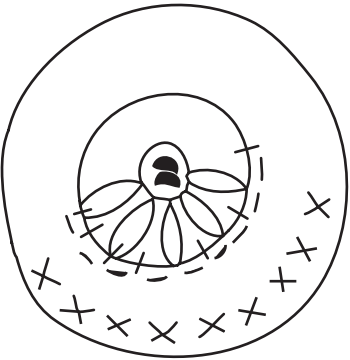
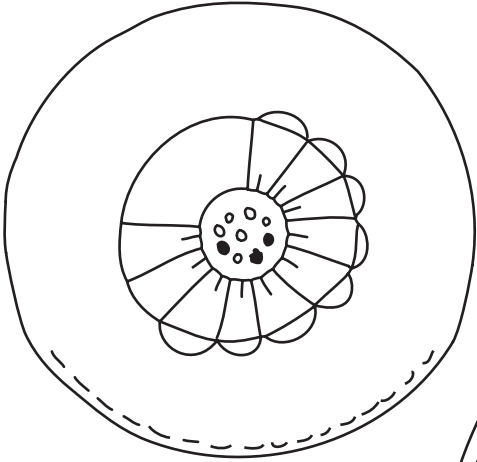
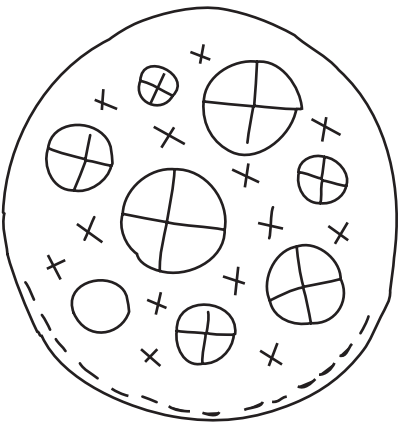
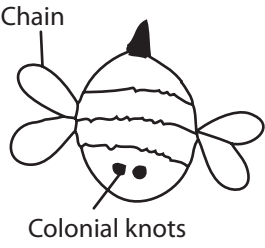
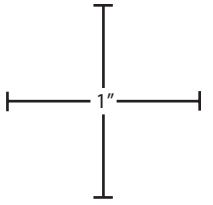

Leaves row 6

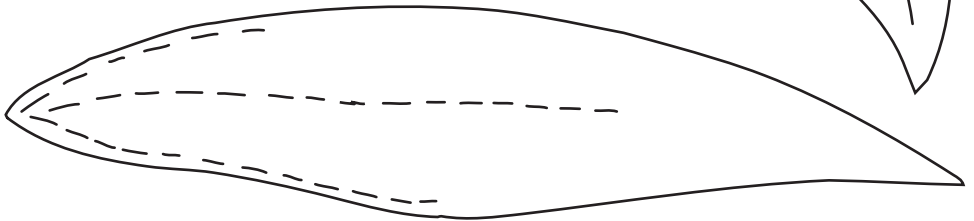
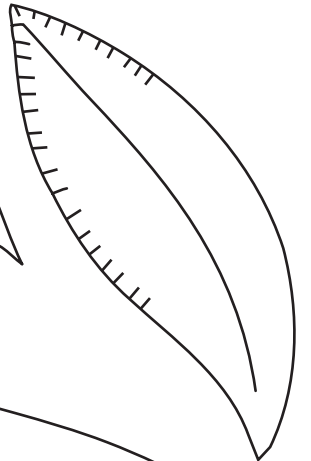
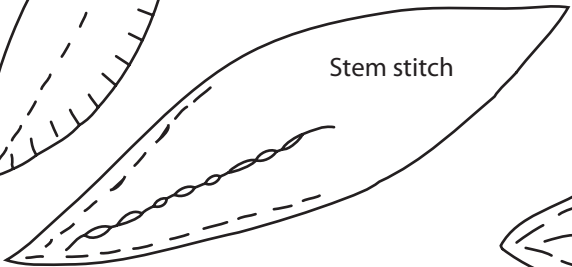
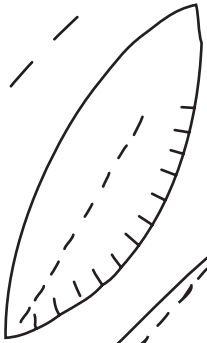
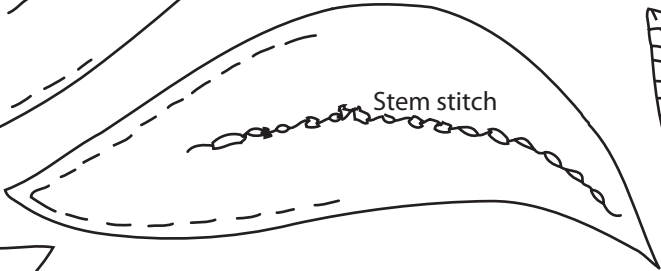
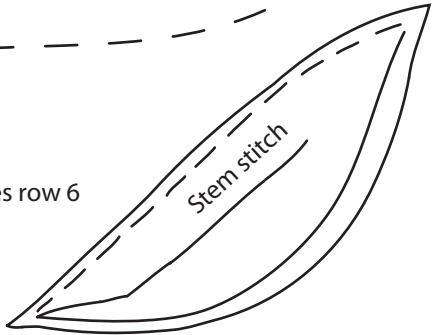

Overgrown appliqué patterns

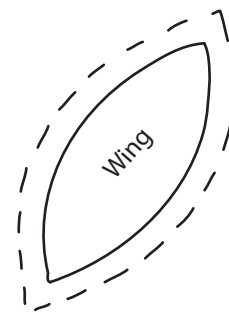
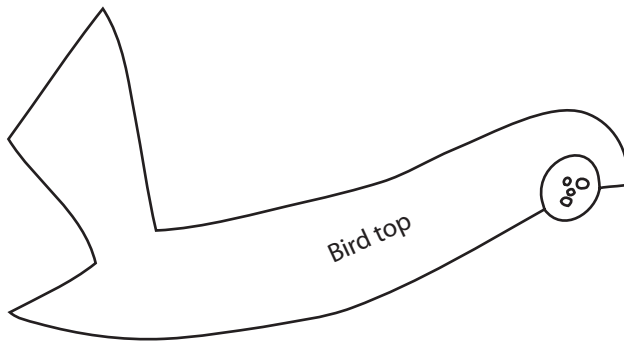
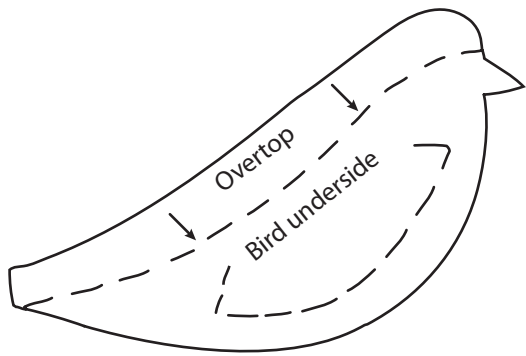

Leaves for flowers

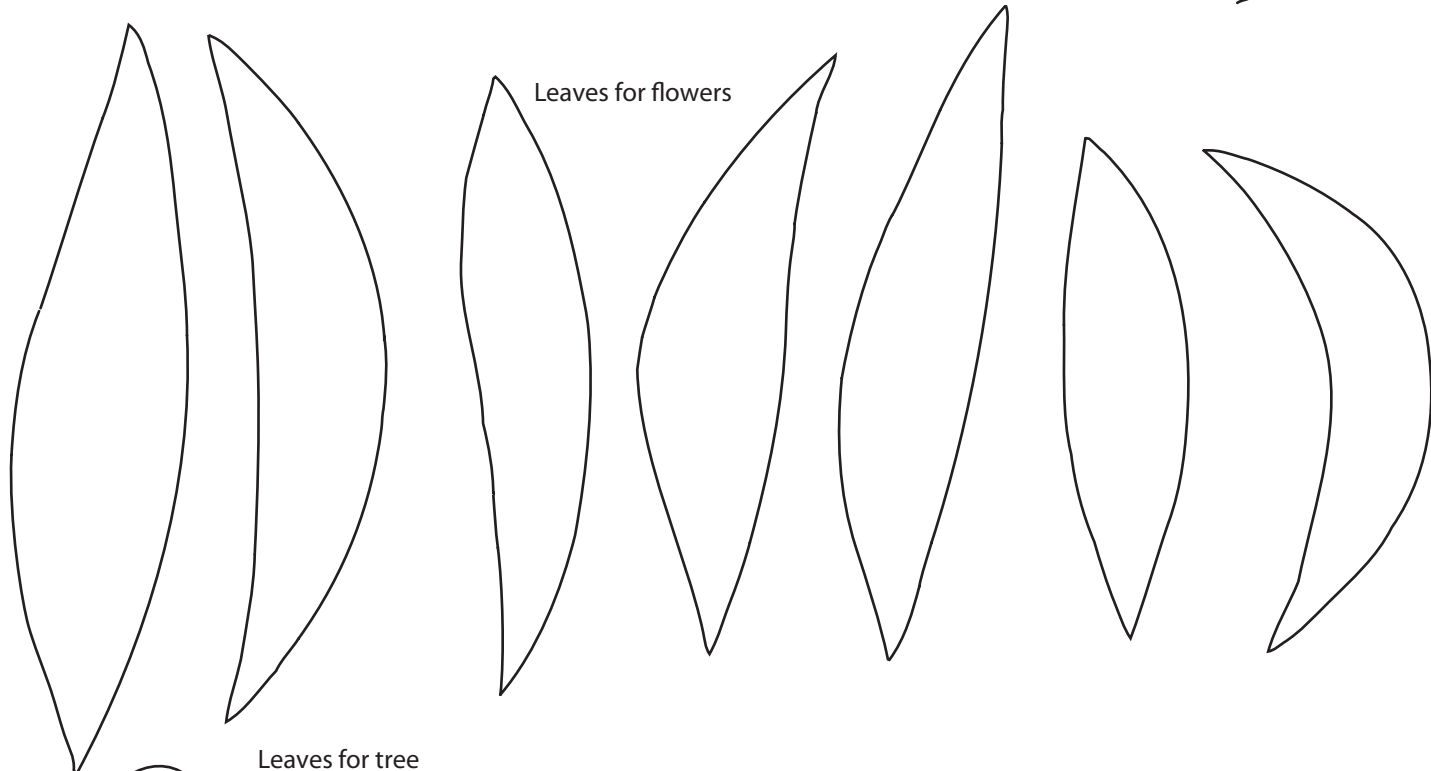

Leaves for tree



Circle centers for tree flowers

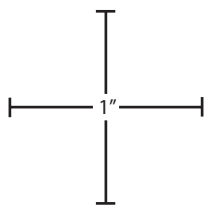
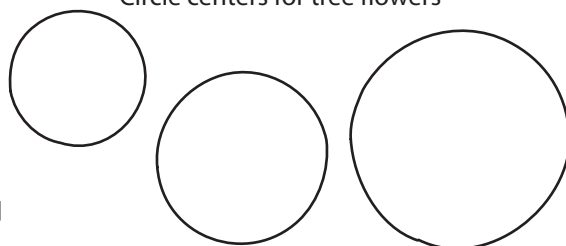

Circle centers for flower garden

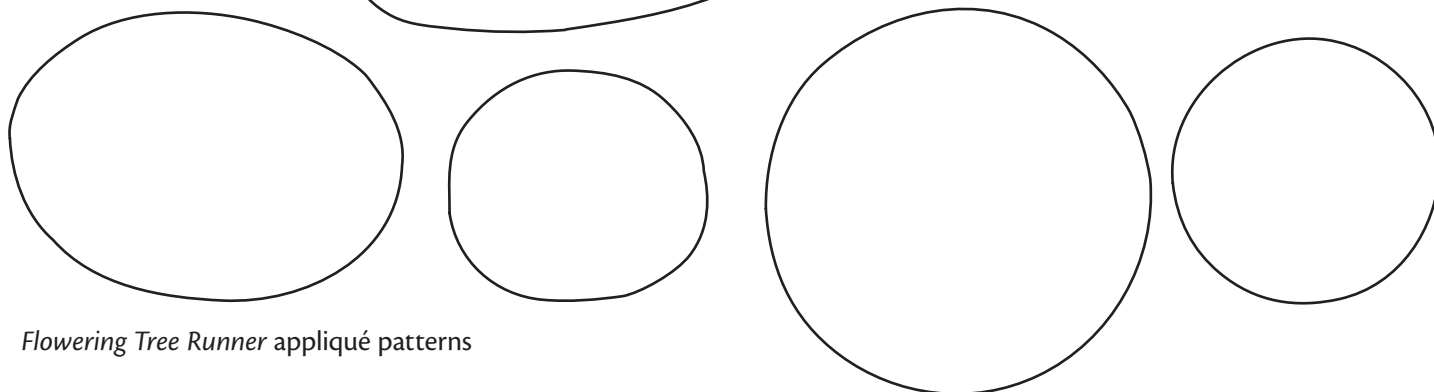

Flowering Tree Runner appliqué patterns

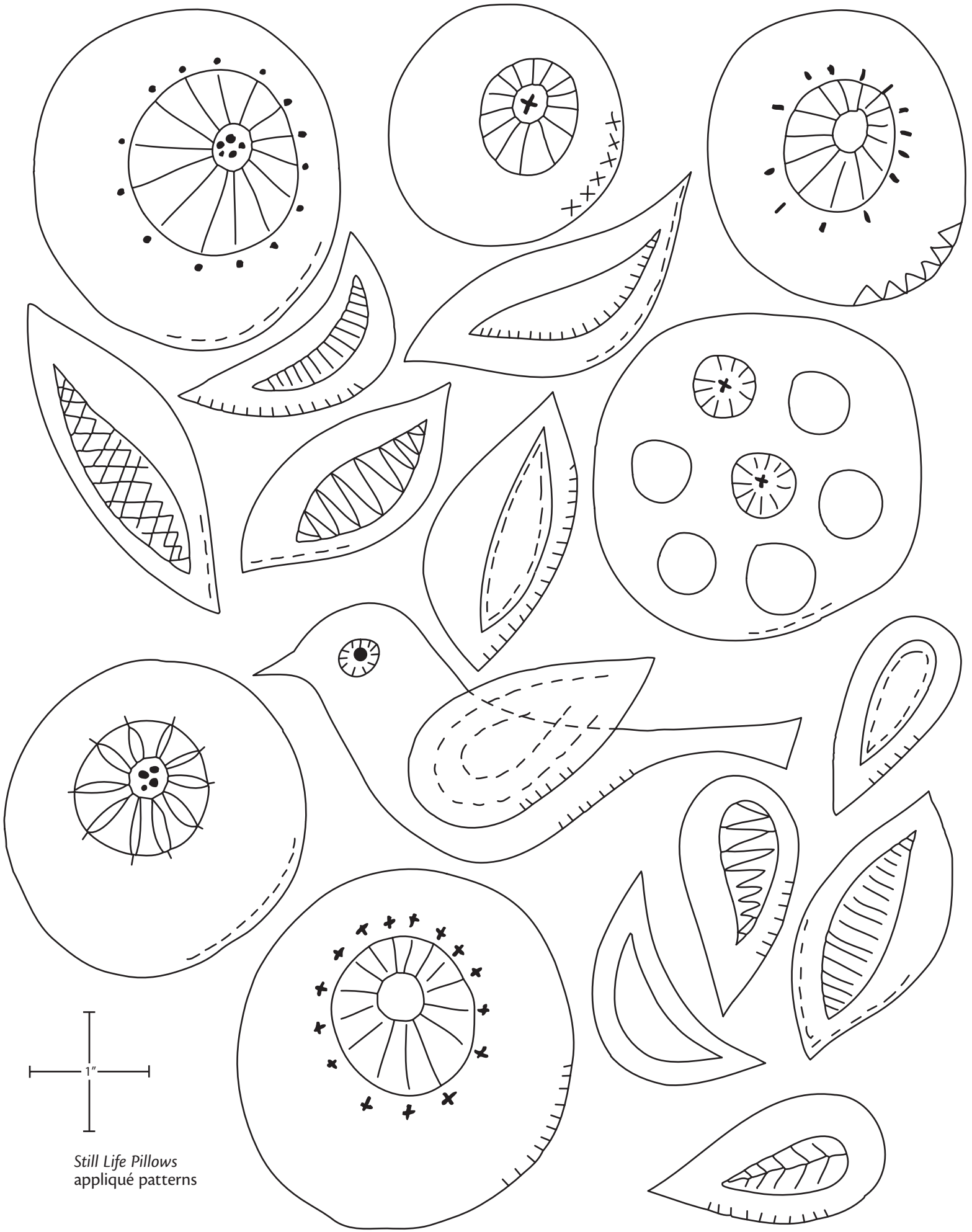

Still Life Pillows
appliqué patterns

Vase 1
(no seam allowance)

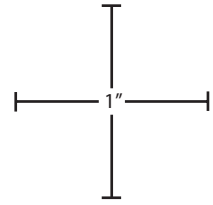

Still Life Pillows appliqué patterns

Vase 2
(no seam allowance)

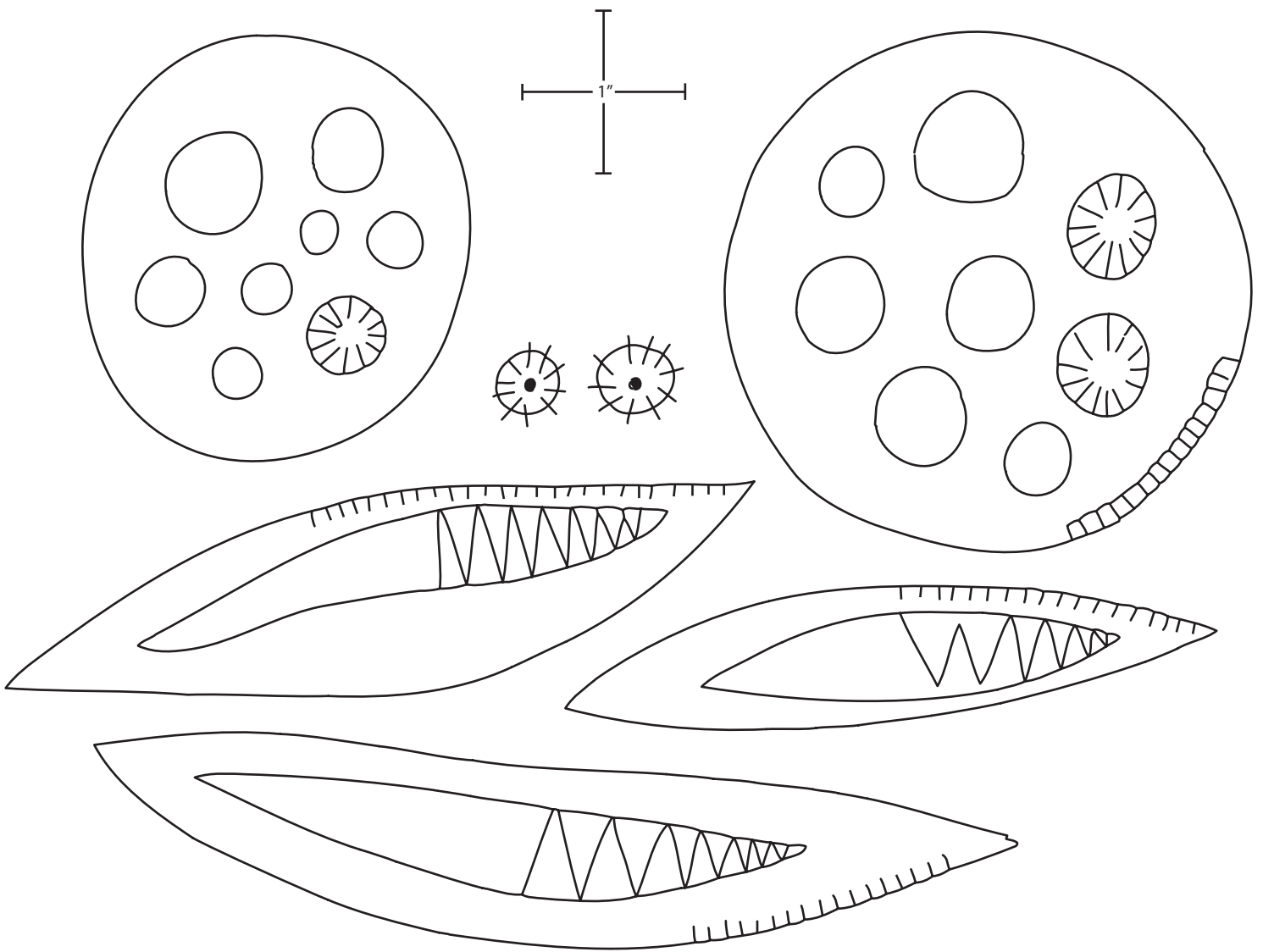

Wildflowers Bag appliqué patterns

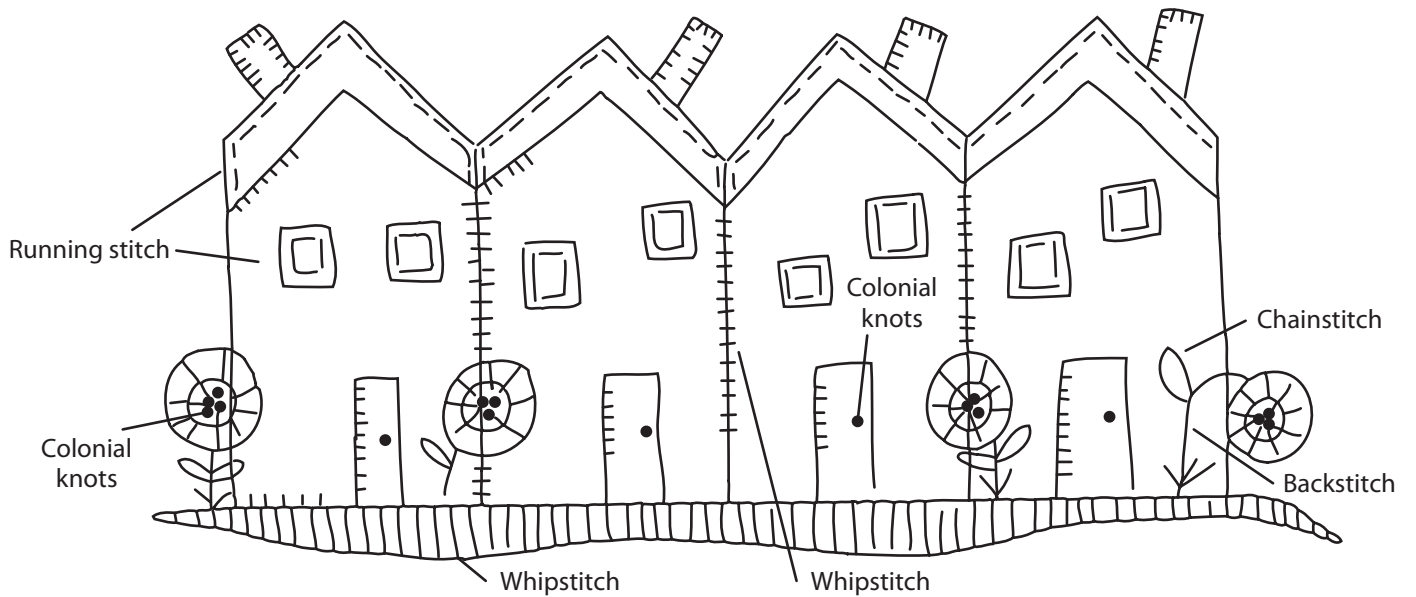

Woolly Needle Case appliqué patterns

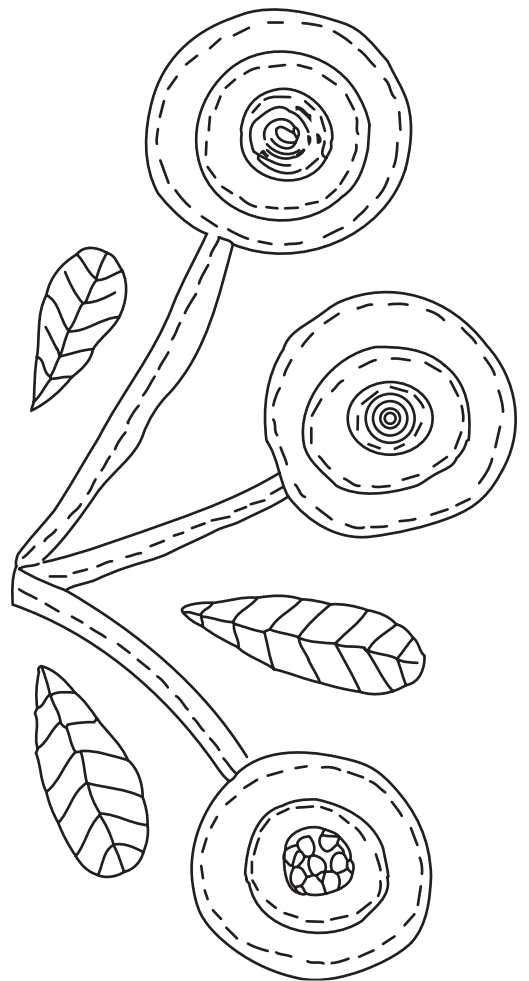
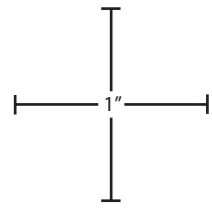
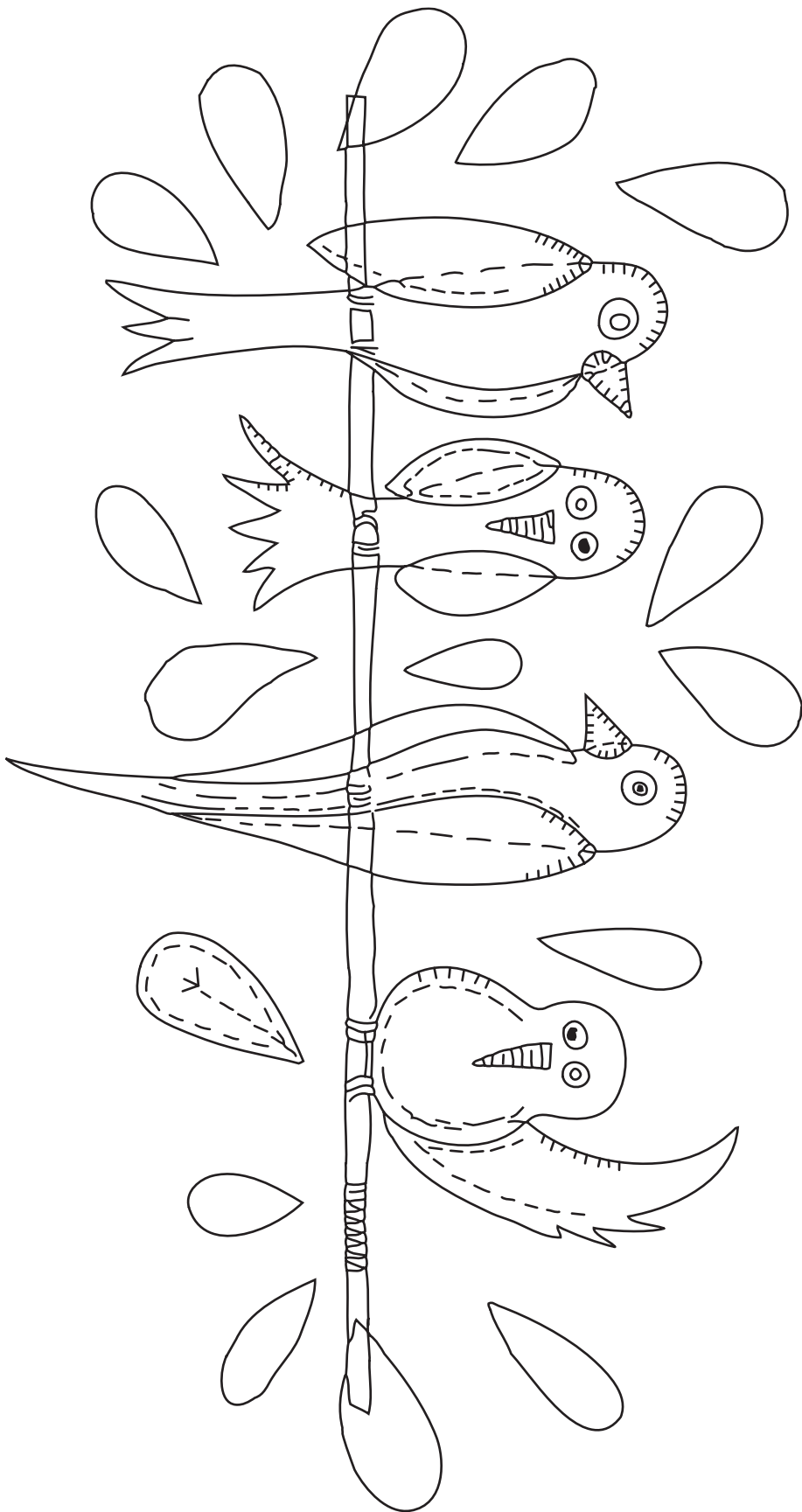

Little Birds Sewing Kit appliqué patterns

Lovebird Pillows

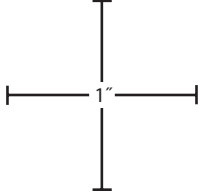

Use a ruler to measure these inch marks to verify that printout is correctly sized.

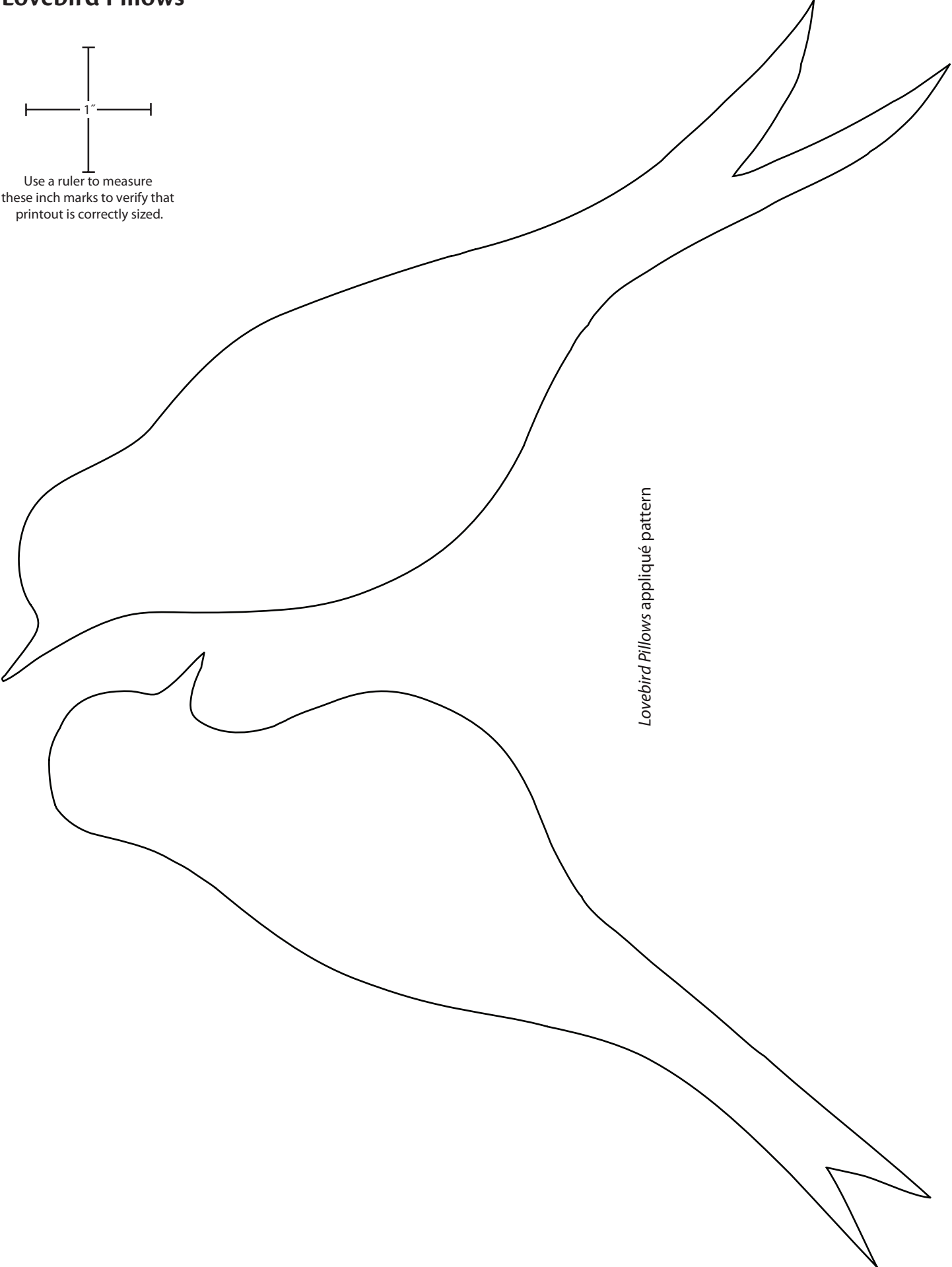

Lovebird Pillows appliqué pattern

Lovebird Pillows

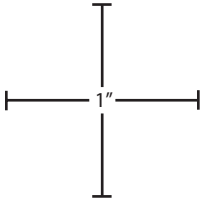

To make complete pattern, join the following pages, following the diagram for reference.

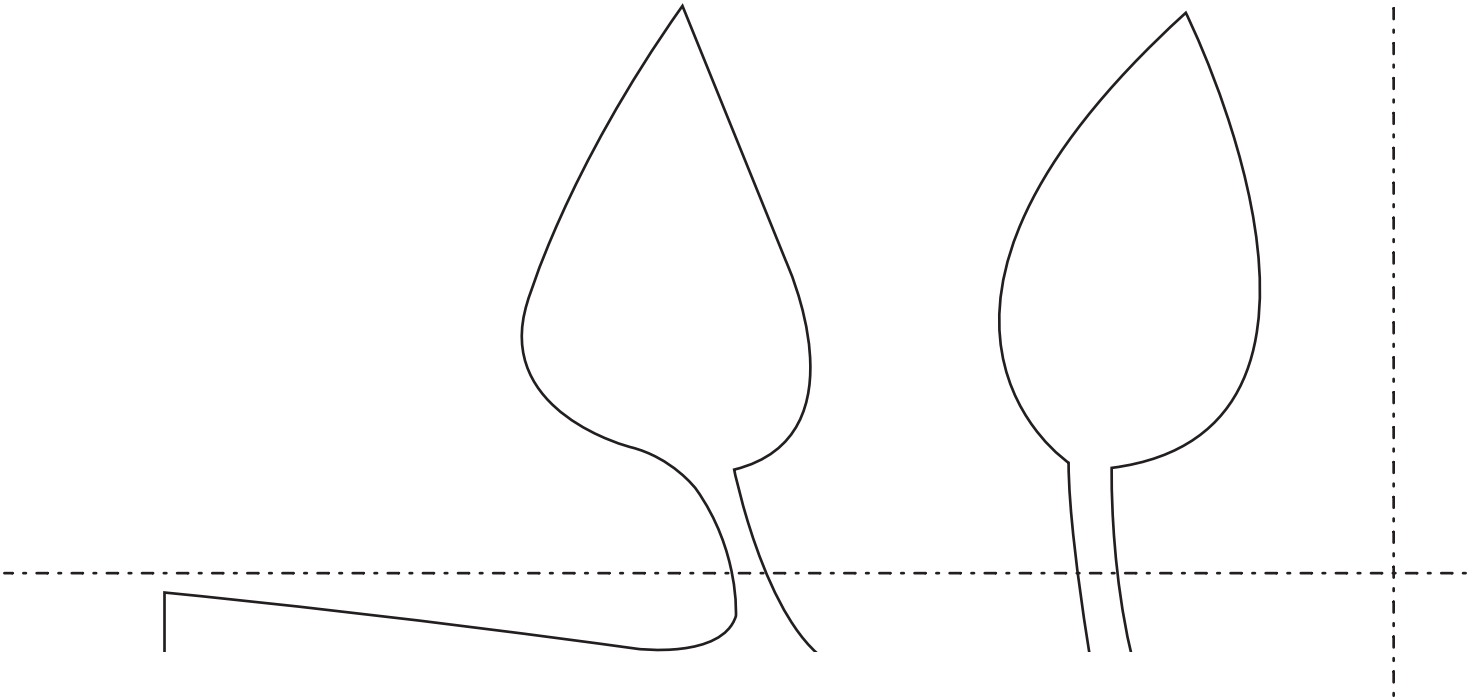
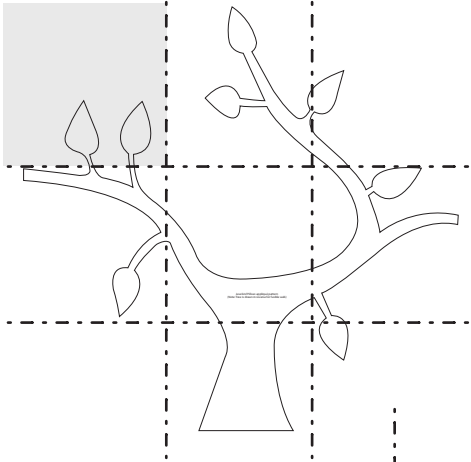

Lovebird Pillows

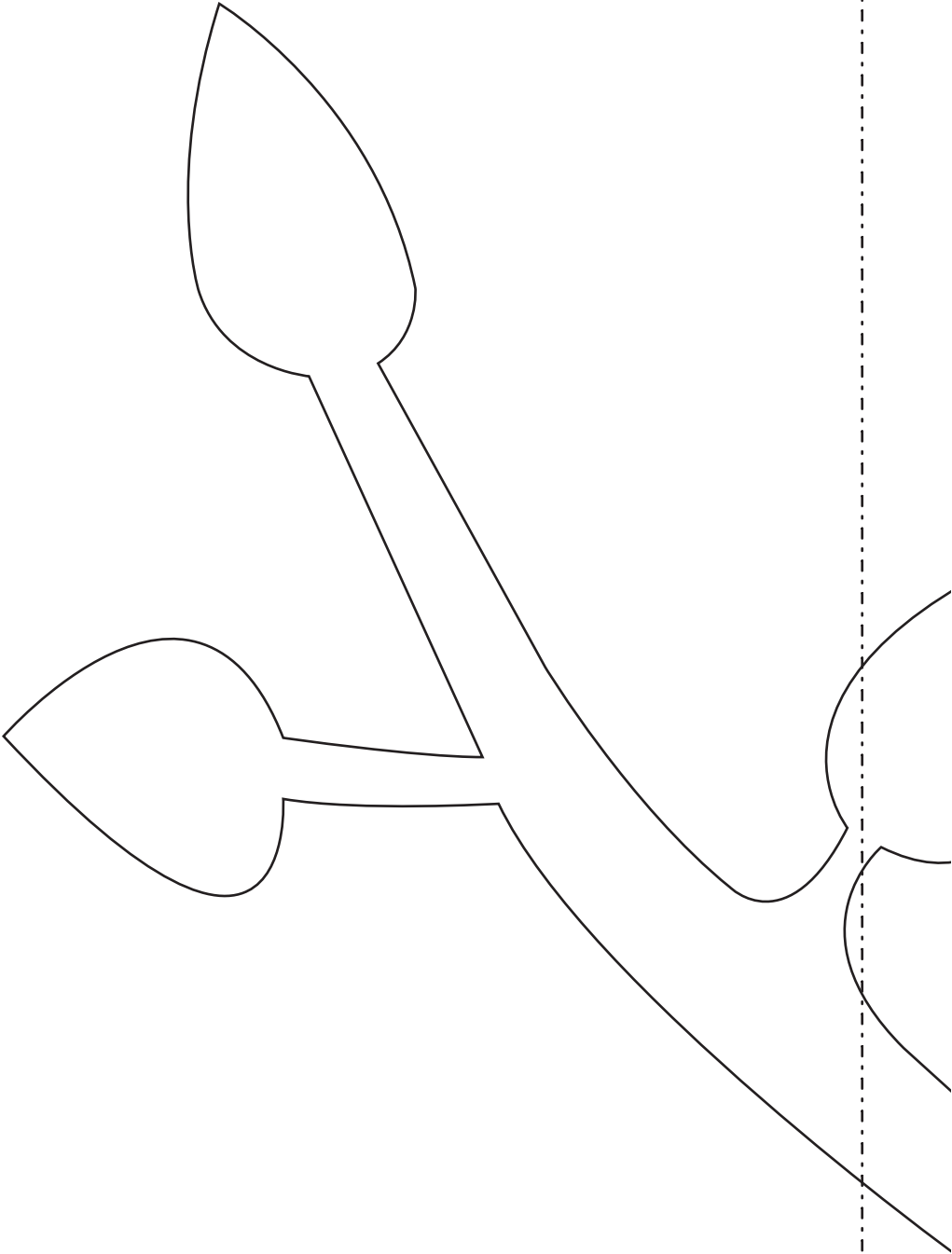
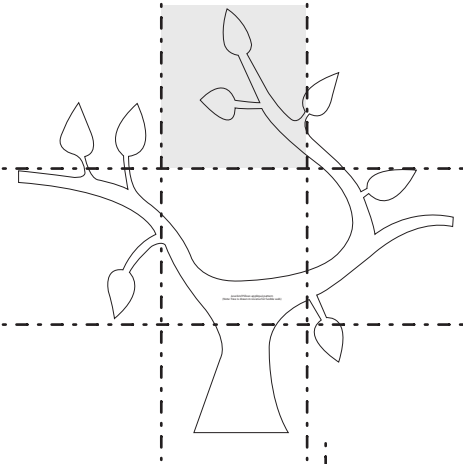
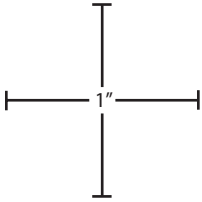

Lovebird Pillows

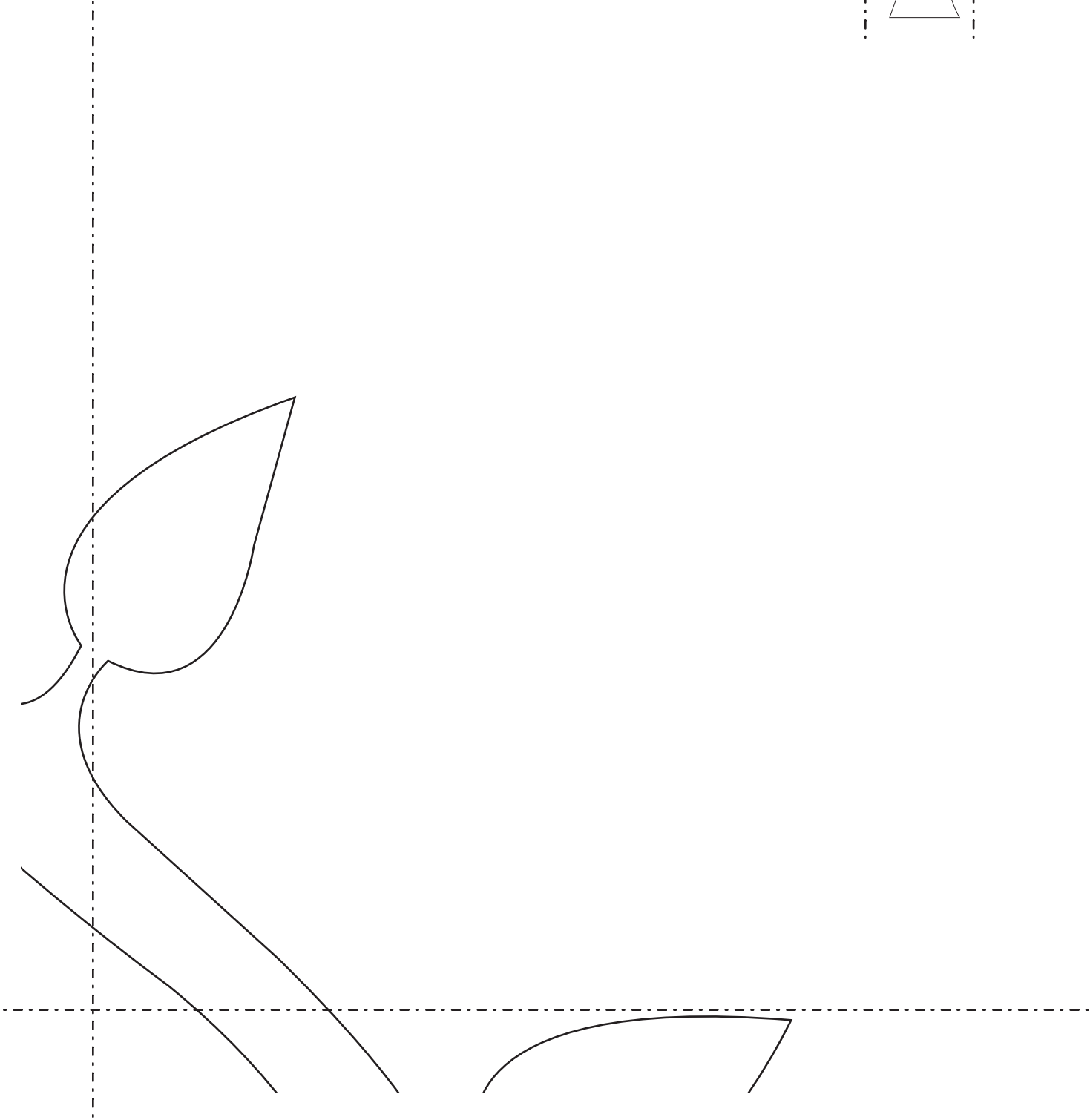
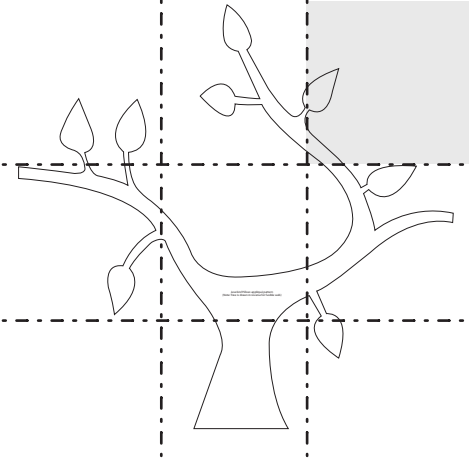
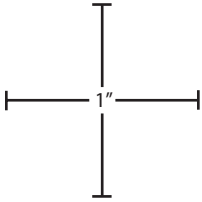

Lovebird Pillows

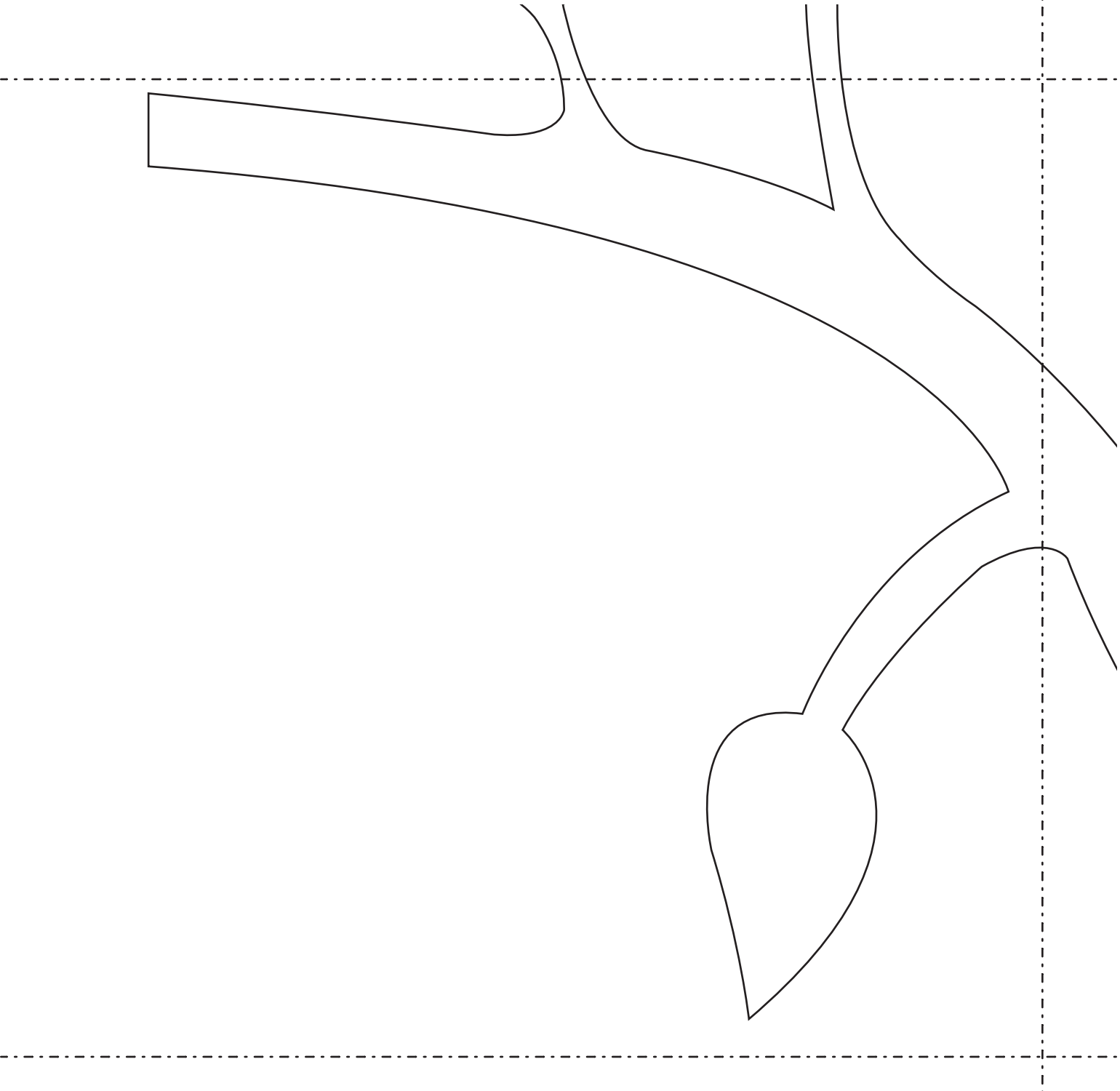
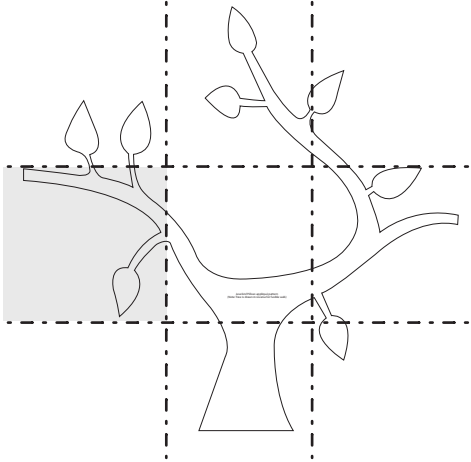
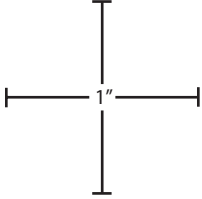

Lovebird Pillows

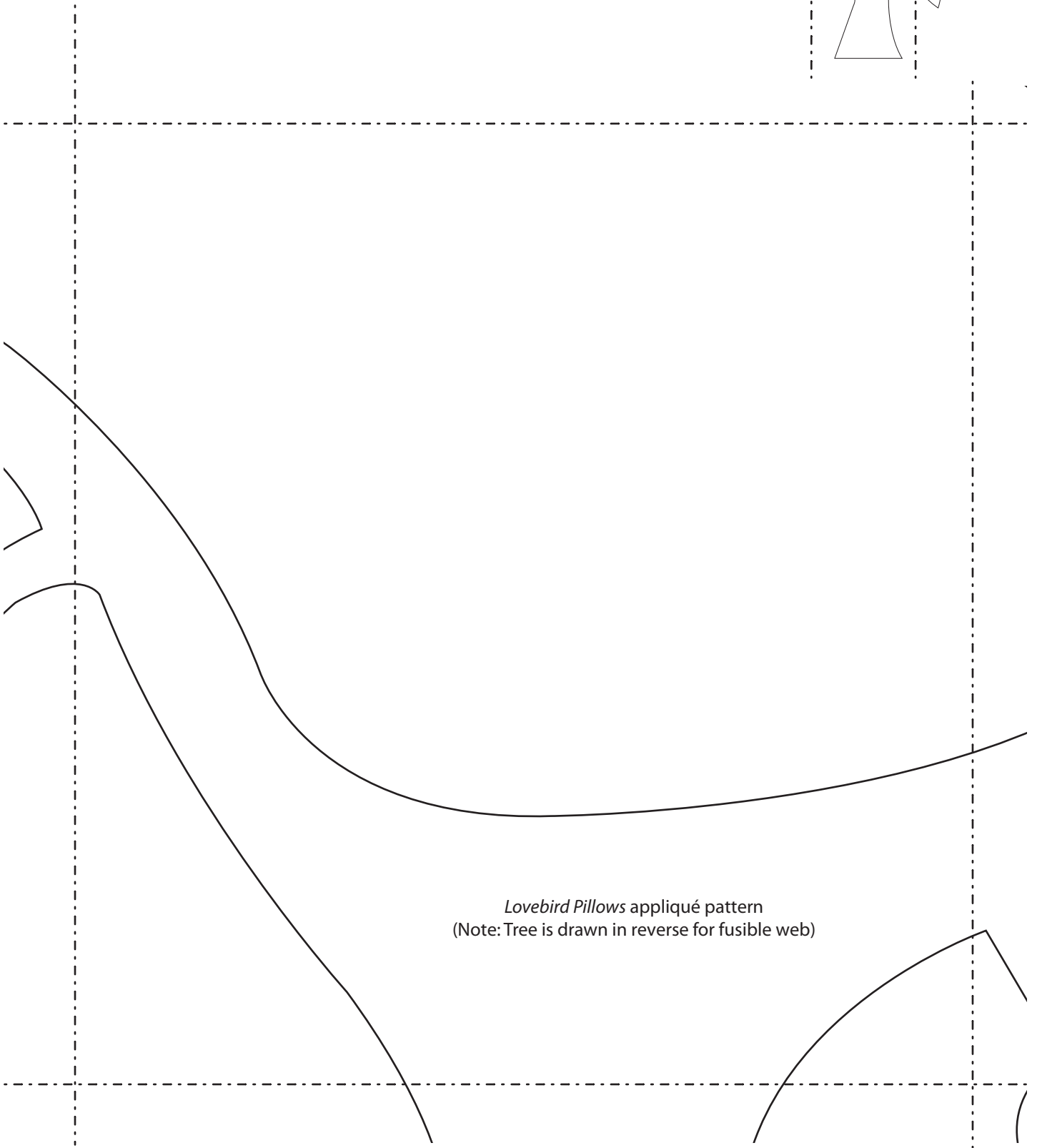
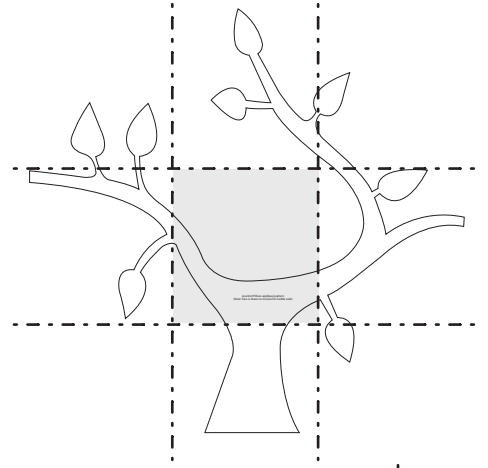
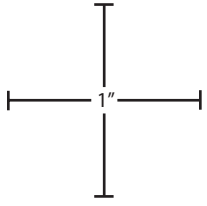

Lovebird Pillows appliqué pattern
(Note: Tree is drawn in reverse for fusible web)

Lovebird Pillows

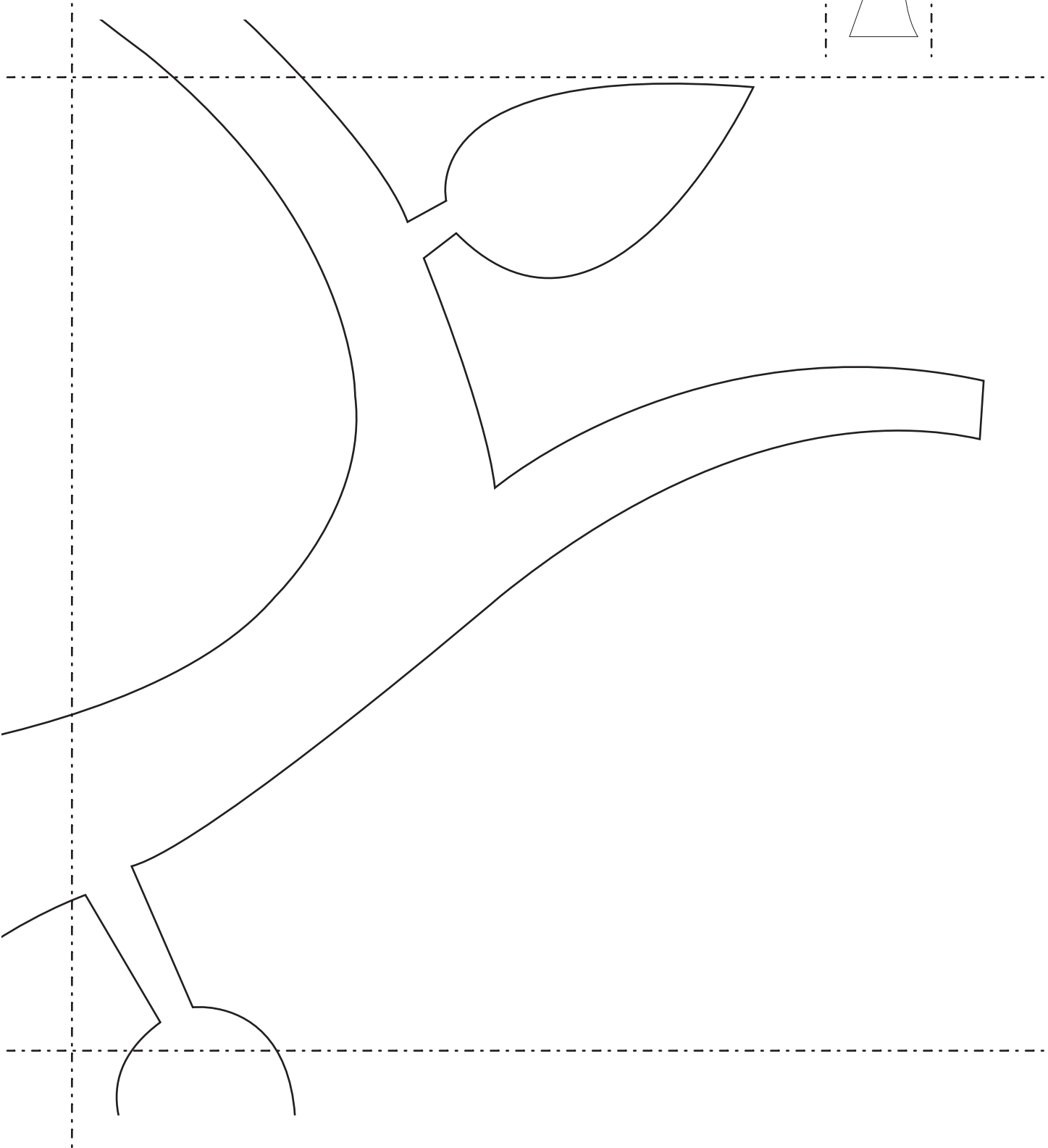
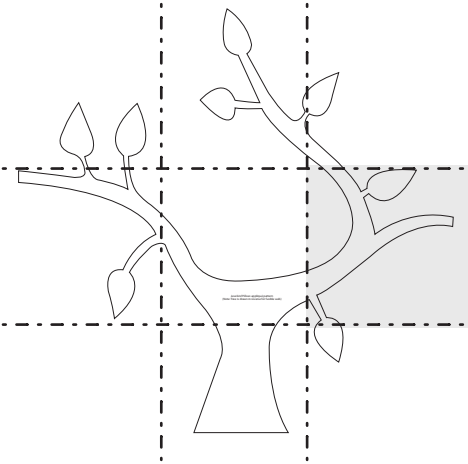
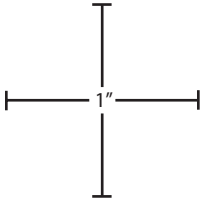

Lovebird Pillows

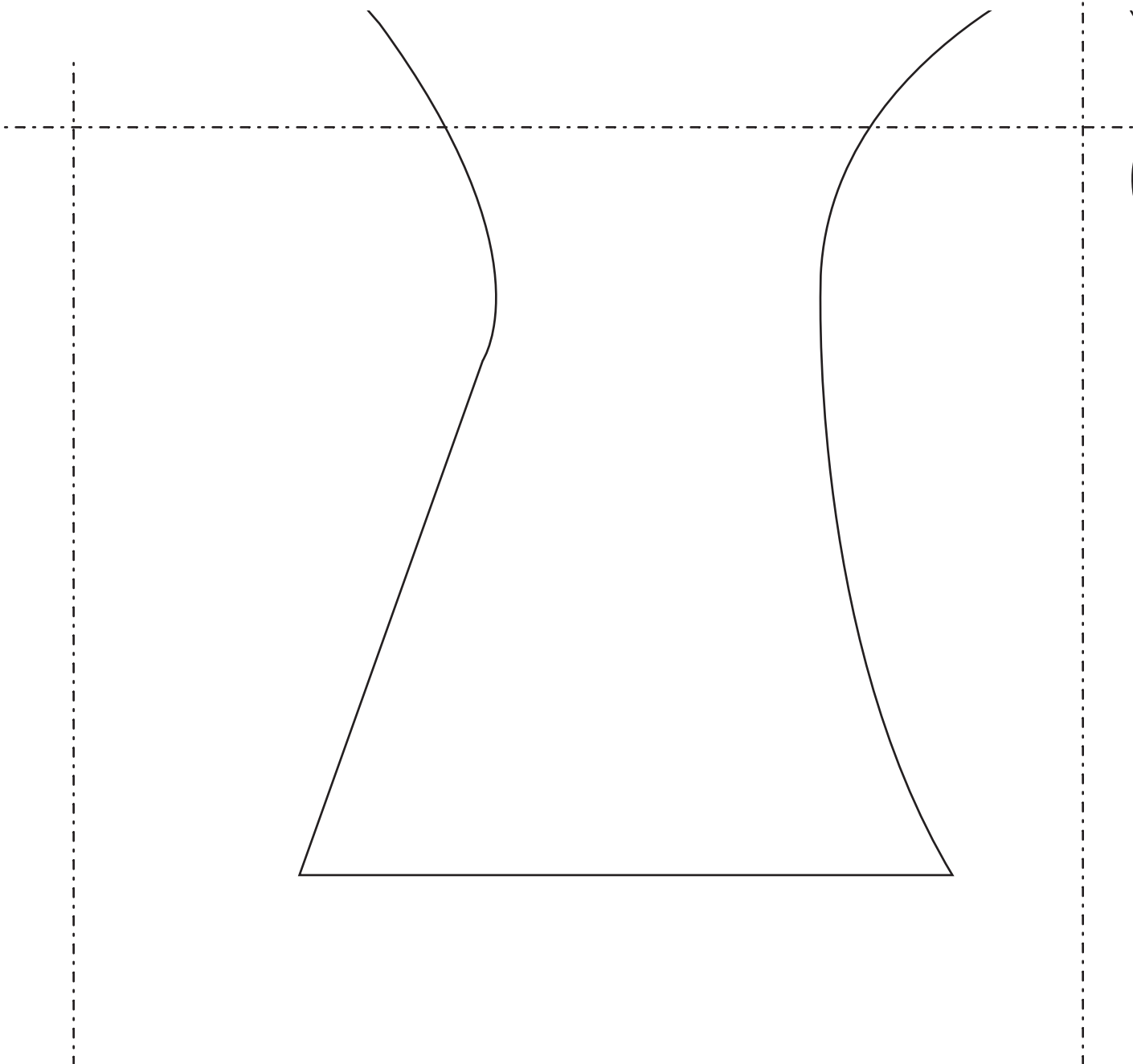
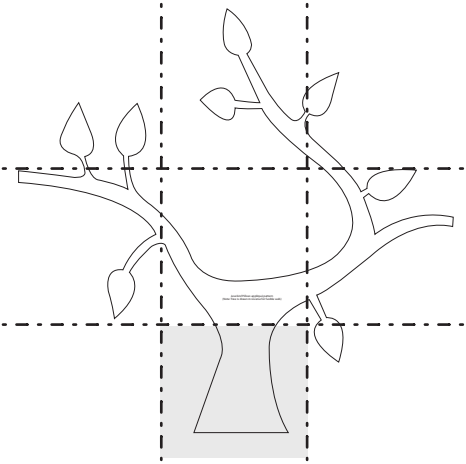
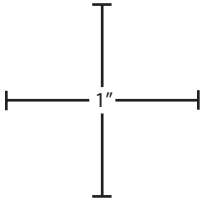

Lovebird Pillows

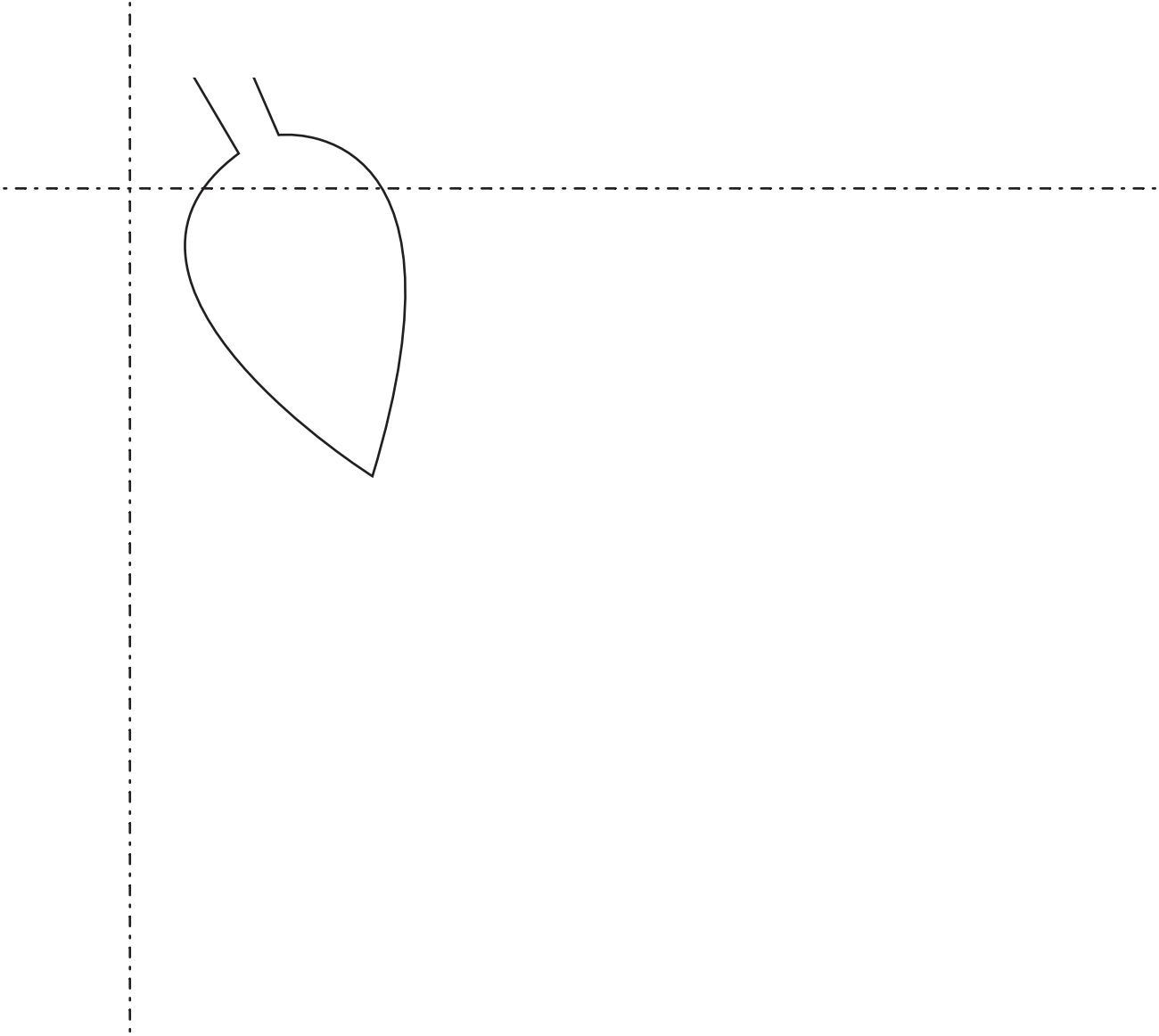
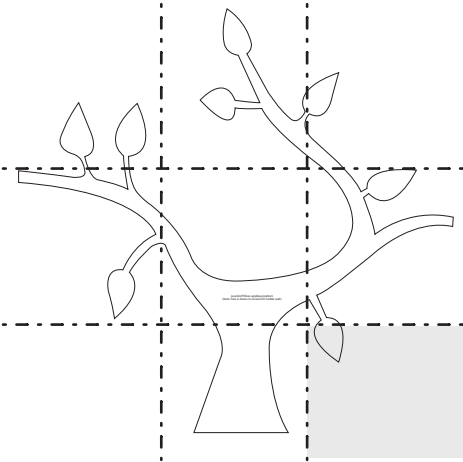
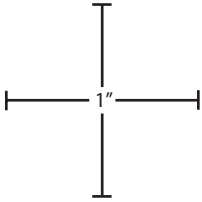

Lovebird Pillows

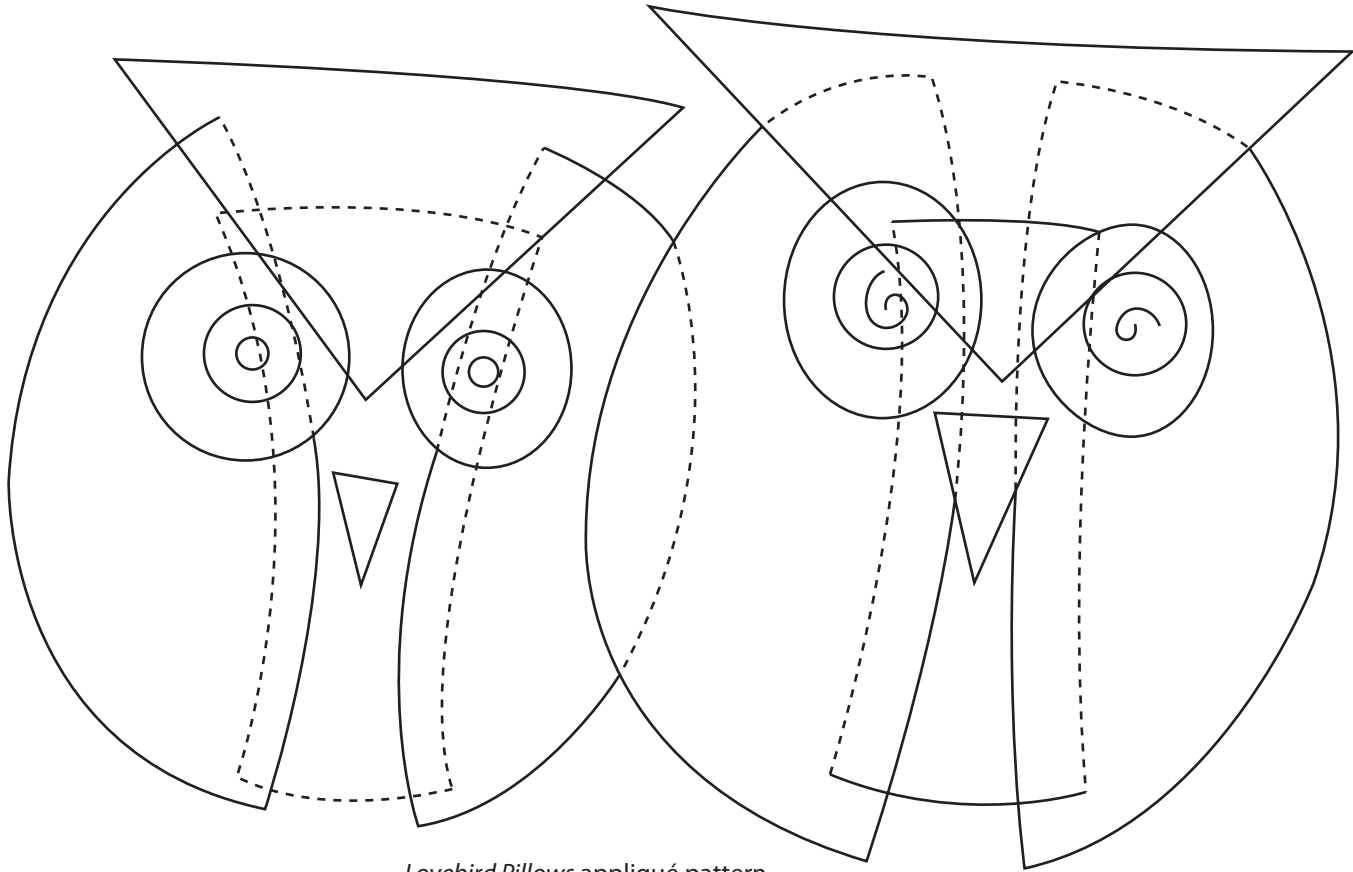
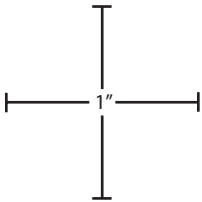

Lovebird Pillows appliqué pattern

Bundles Bag

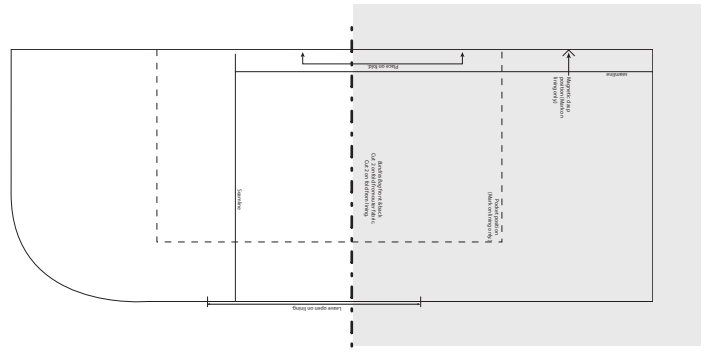
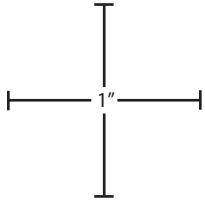

To make complete pattern, join the following pages, following the diagram for reference.

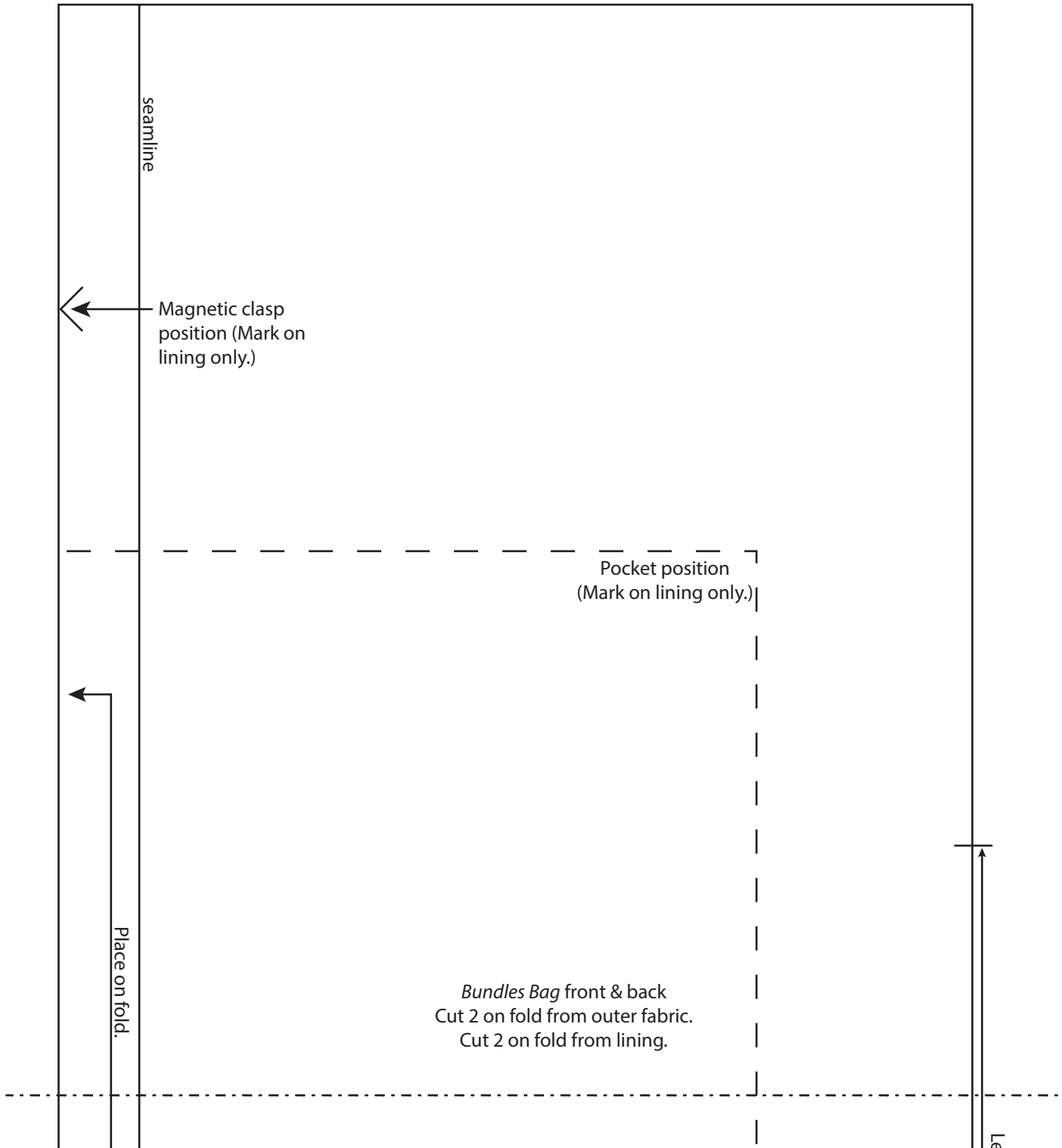

Bundles Bag

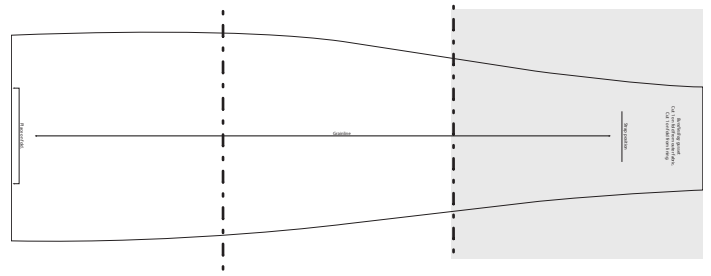
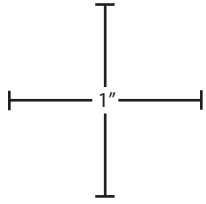

To make complete pattern, join the following pages, following the diagram for reference.

Bundles Bag gusset
Cut 1 on fold from outer fabric.
Cut 1 on fold from lining.

Strap position



Bundles Bag

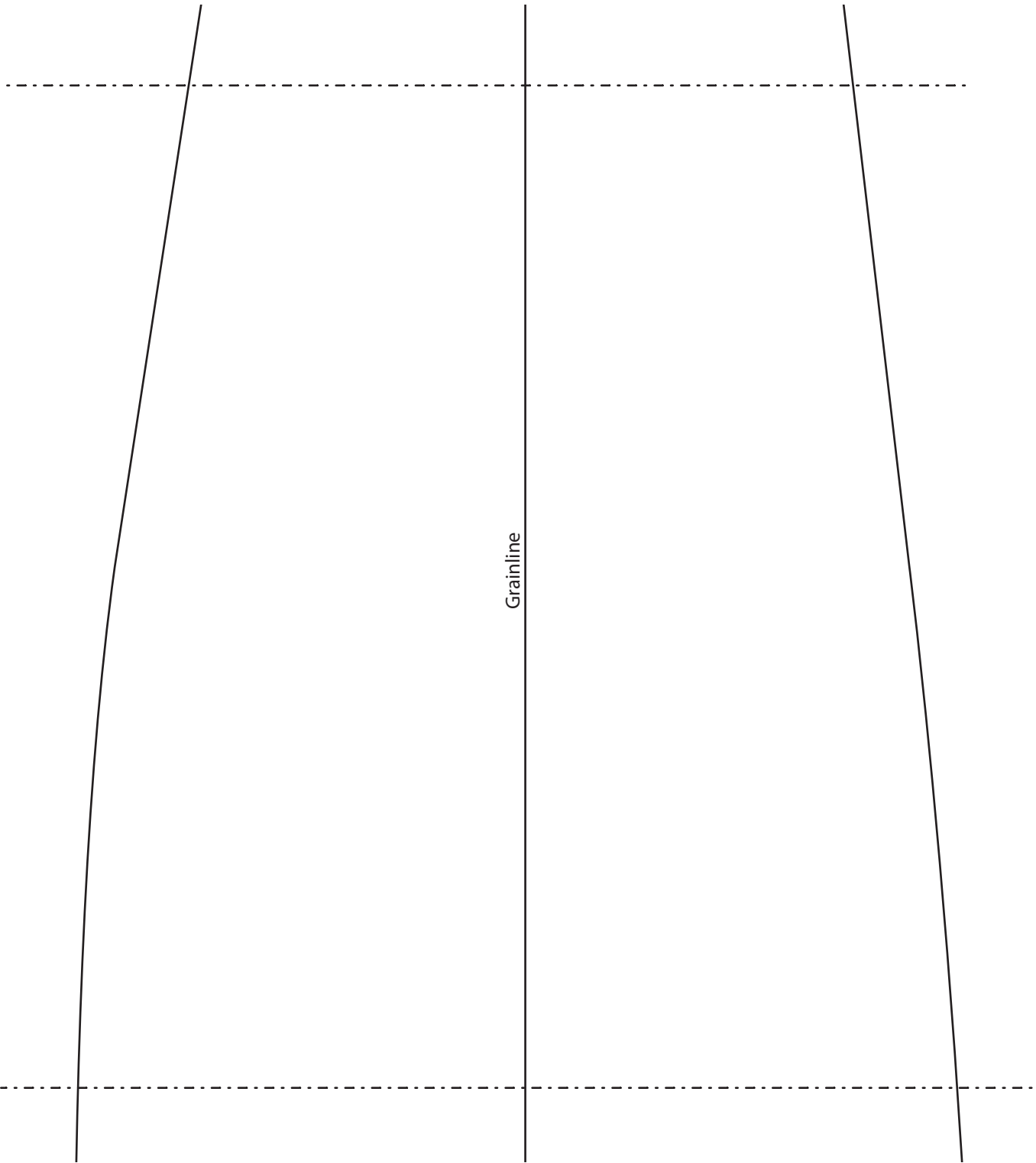
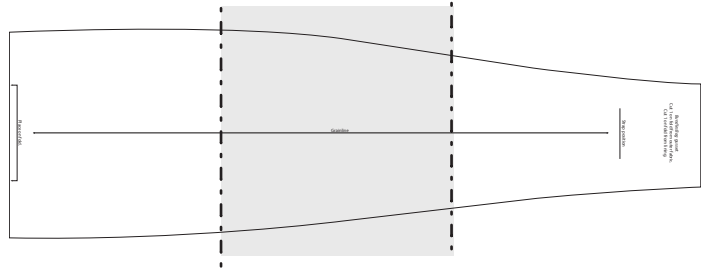
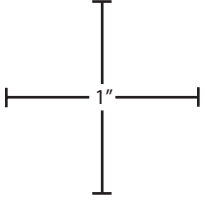

Bundles Bag

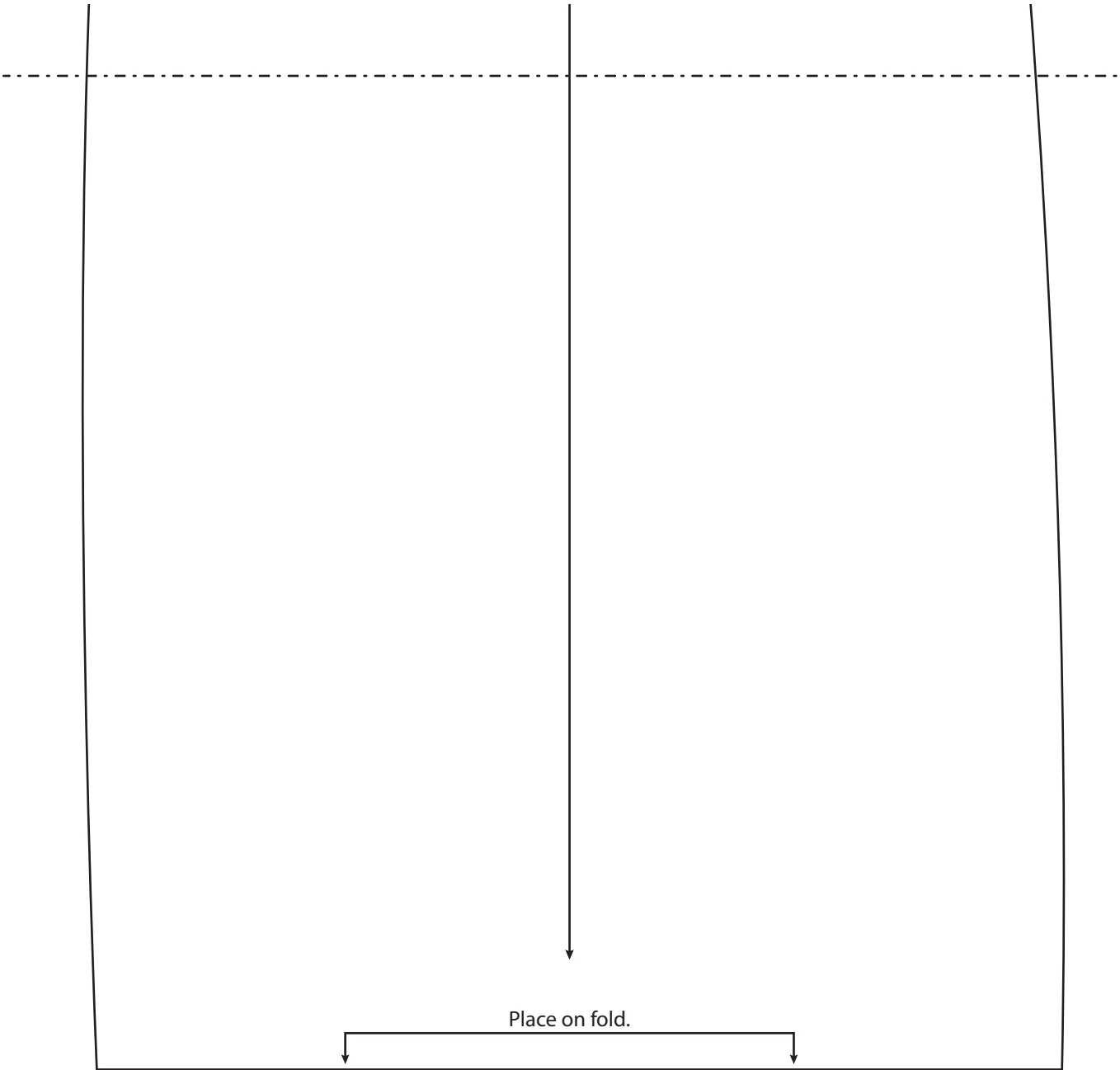
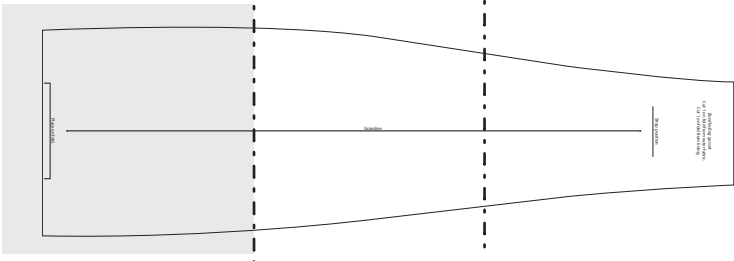
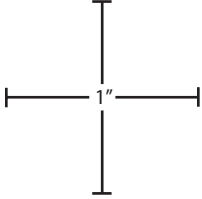

Bundles Bag

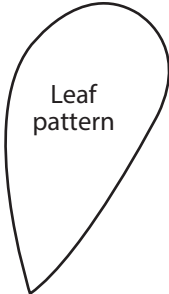
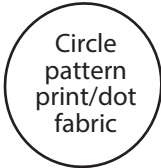
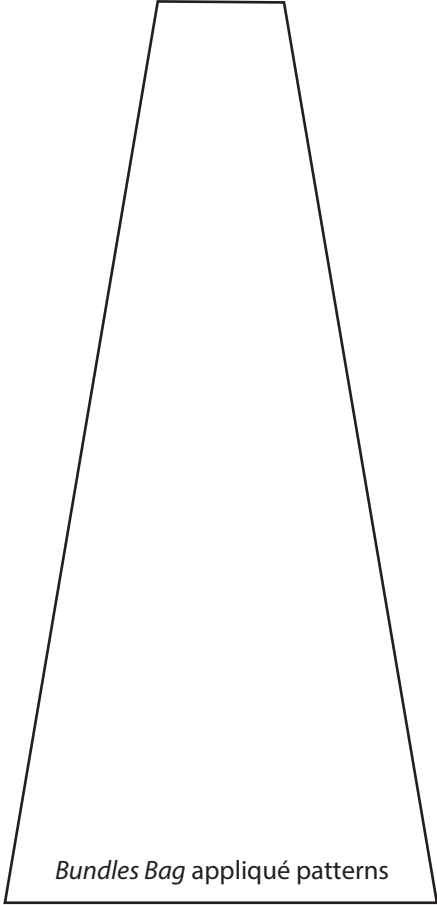
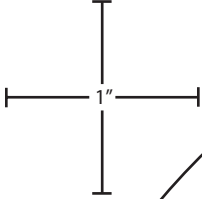

Wee Farm Village Pillow

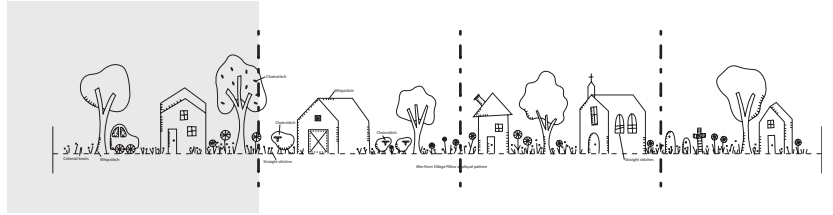
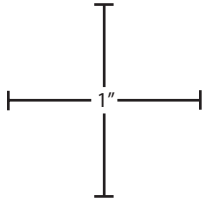

To make complete pattern, join the following pages, following the diagram for reference.

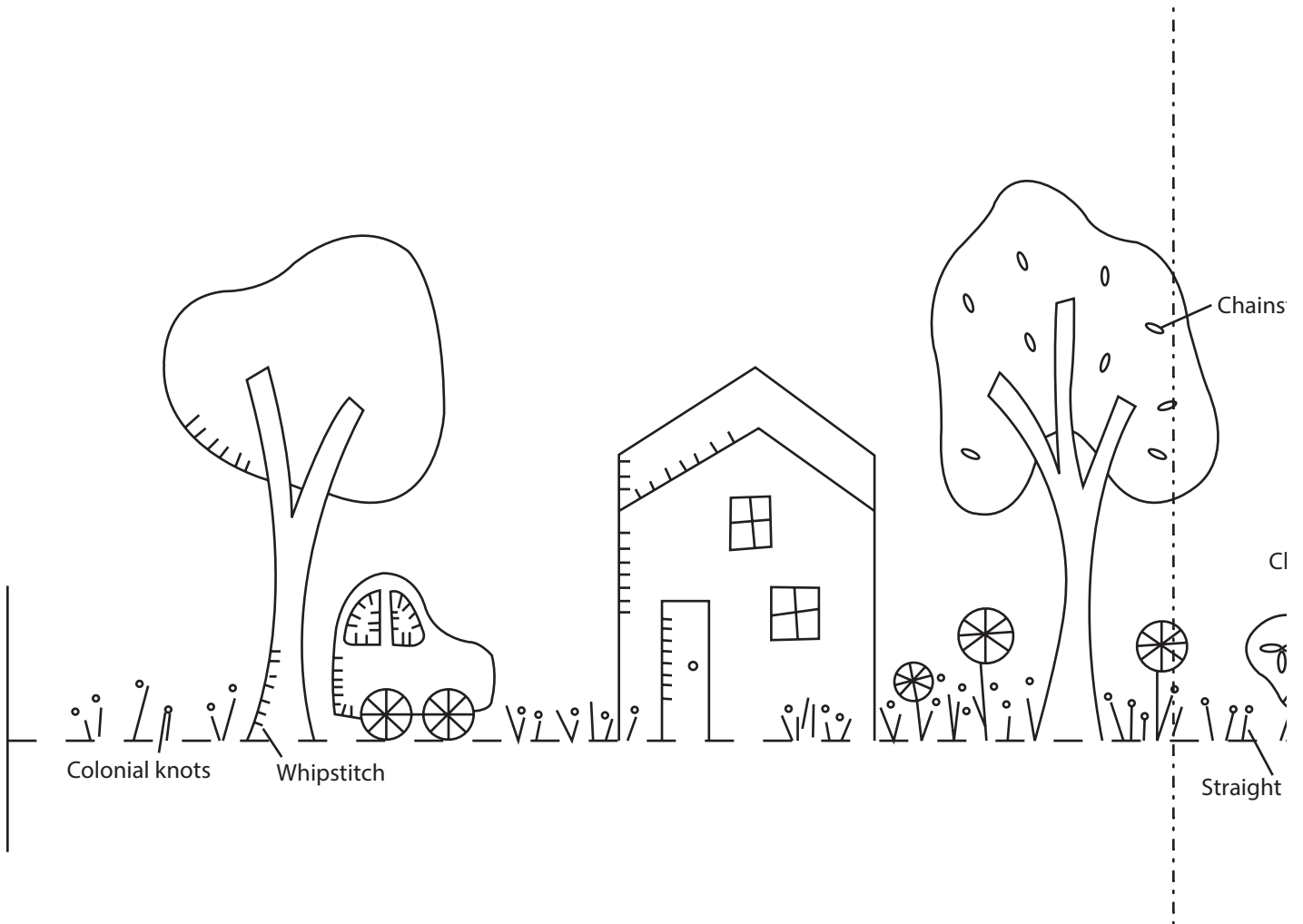

Wee Farm Village Pillow

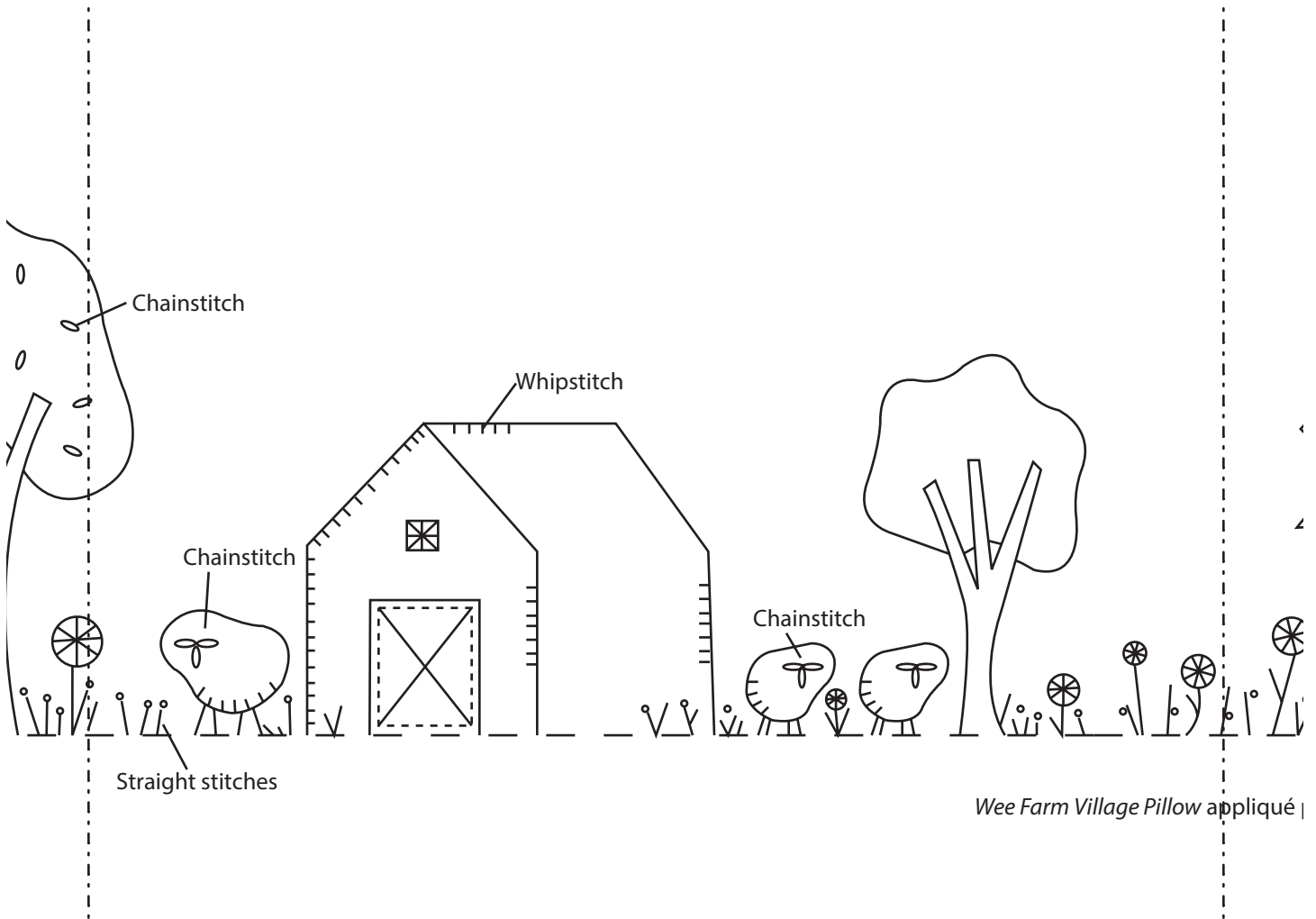
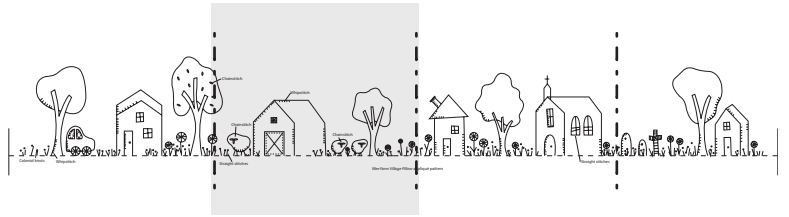
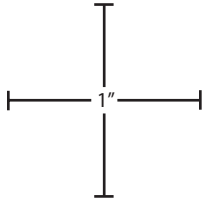

Wee Farm Village Pillow

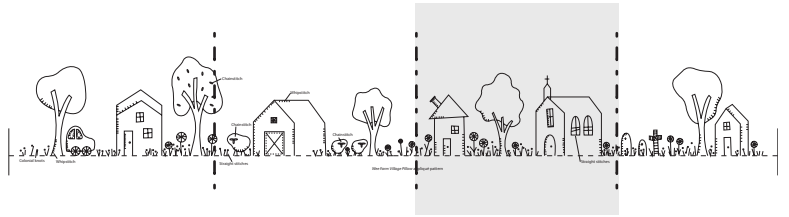
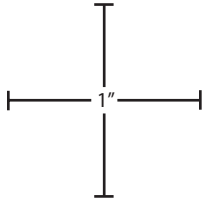

Pillow appliqué pattern

Straight stitches

Wee Farm Village Pillow

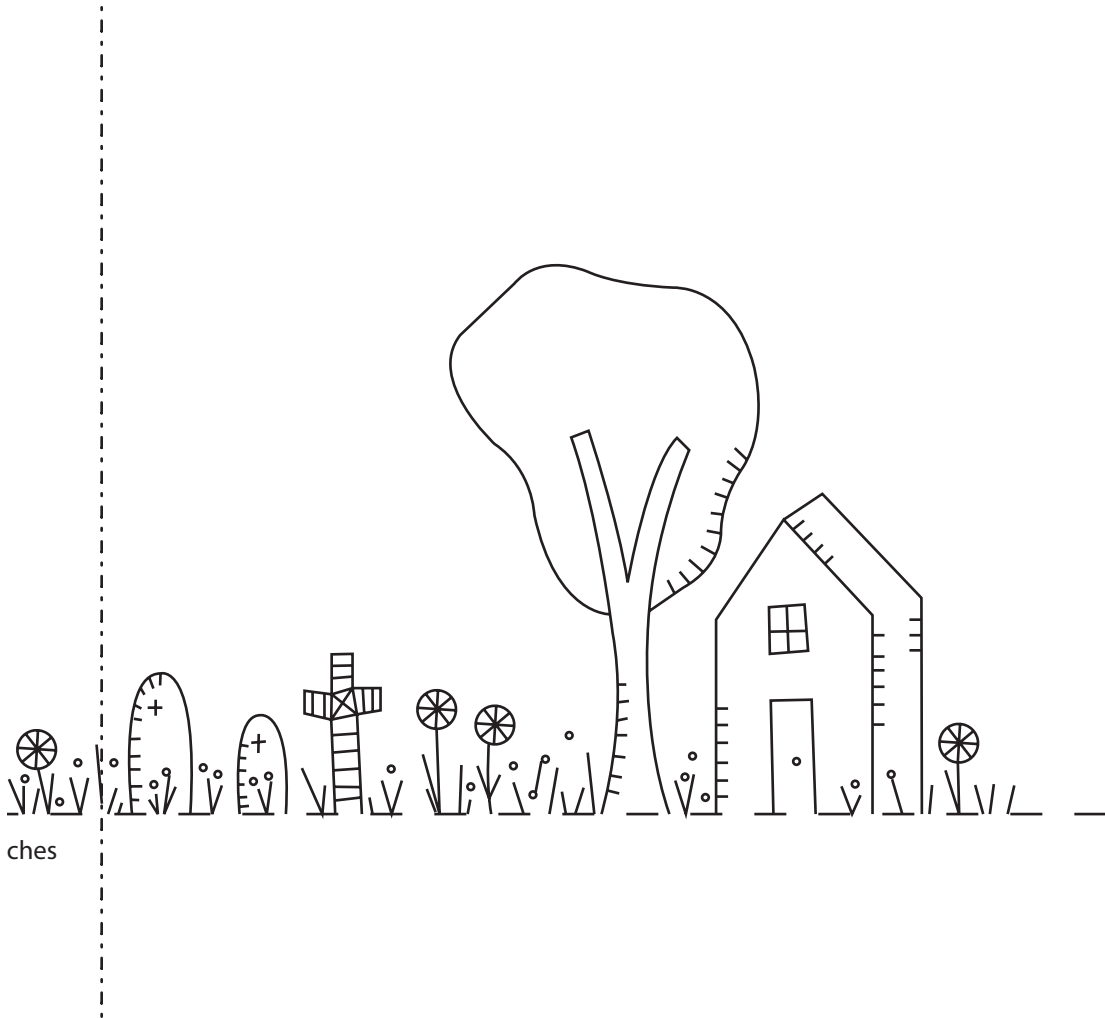
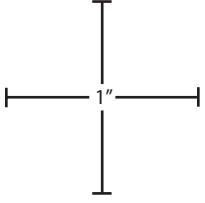

Wee Village Town Pillow

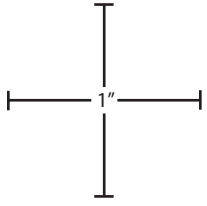

To make complete pattern, join the following pages, following the diagram for reference.

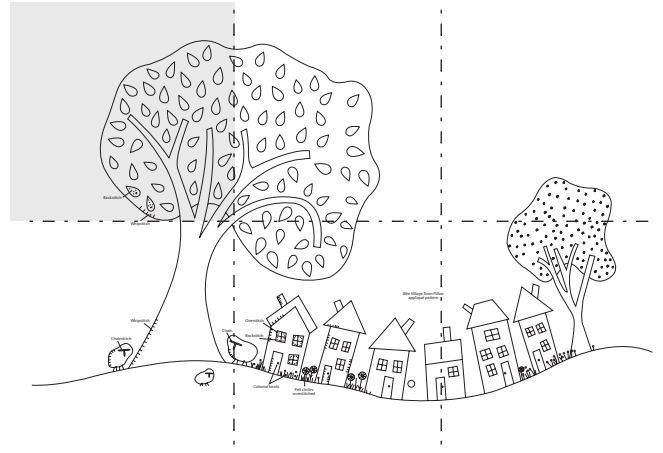

Wee Village Town Pillow

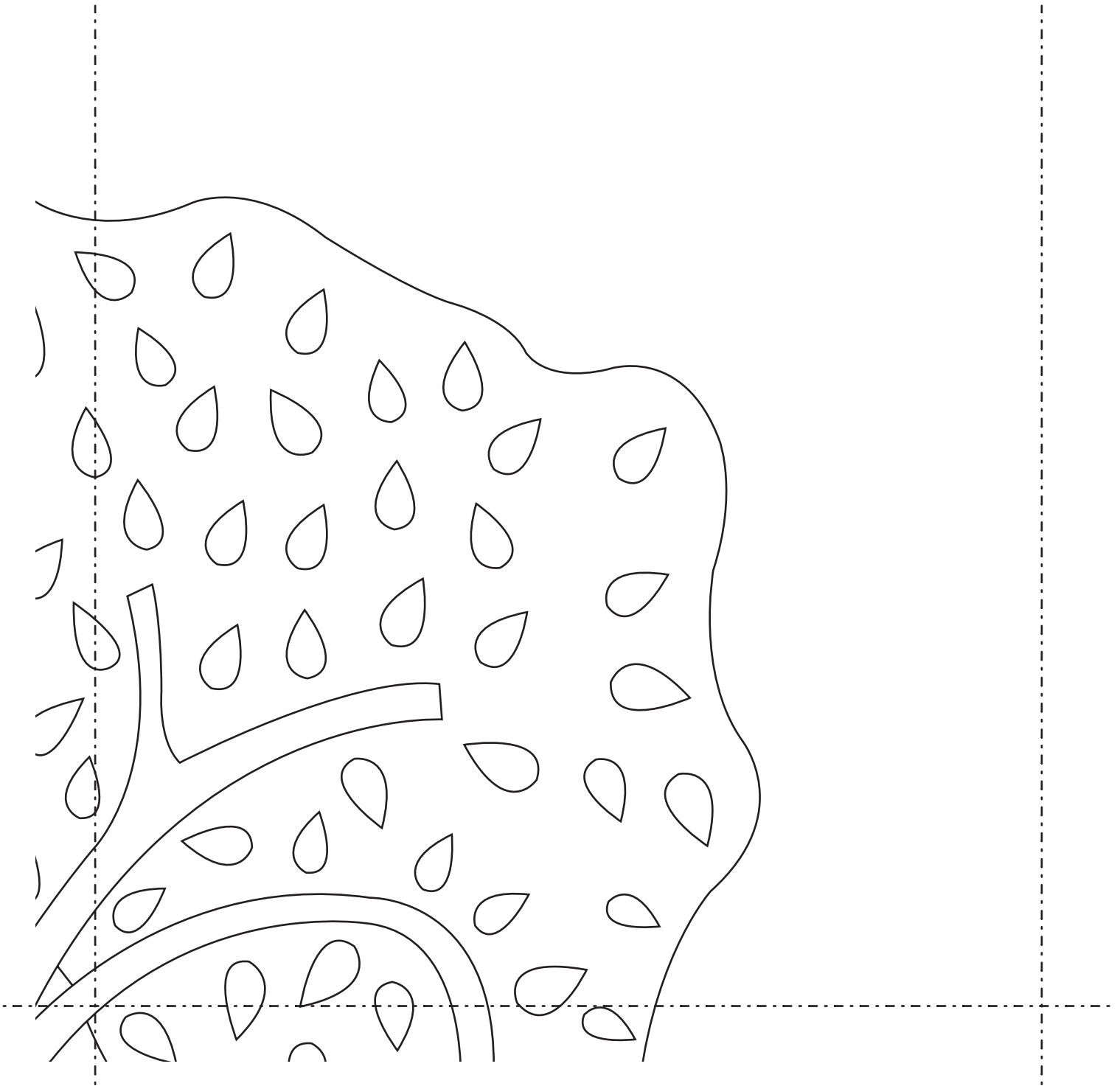
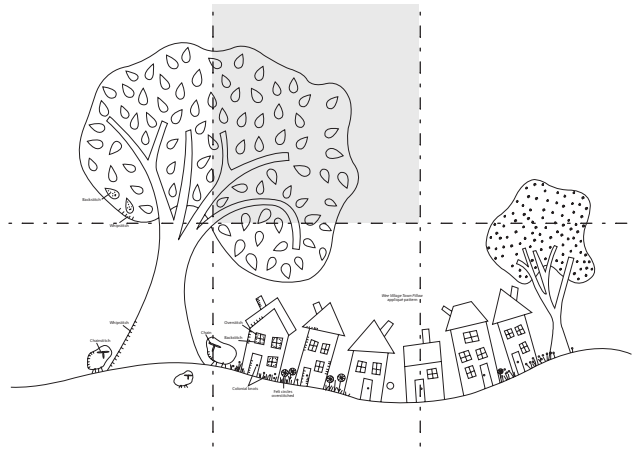
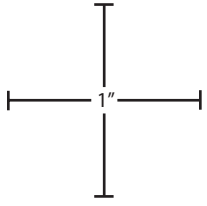

Wee Village Town Pillow

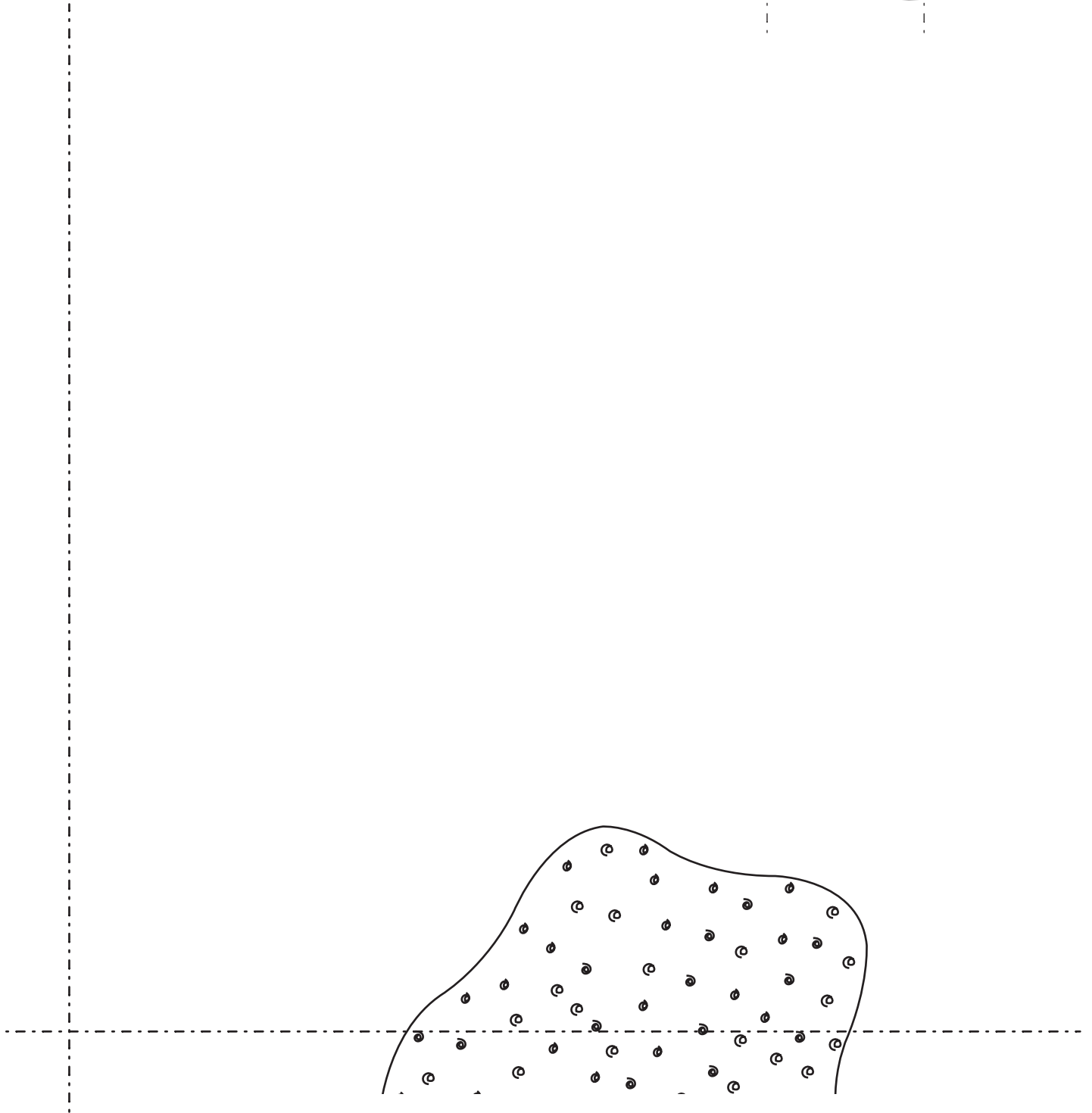
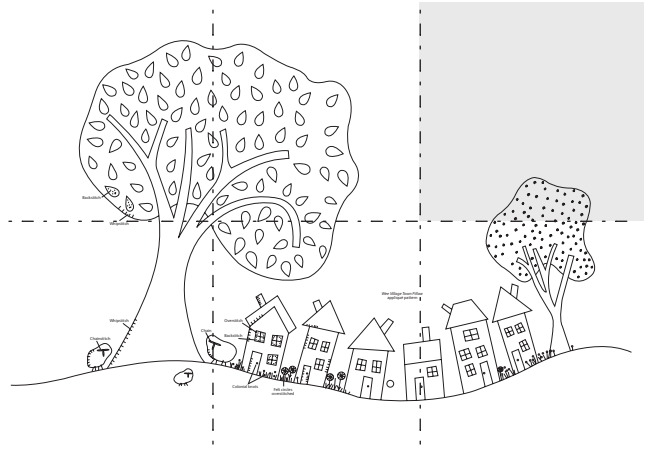
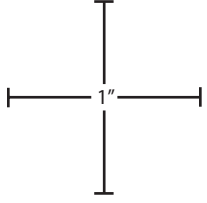

Wee Village Town Pillow

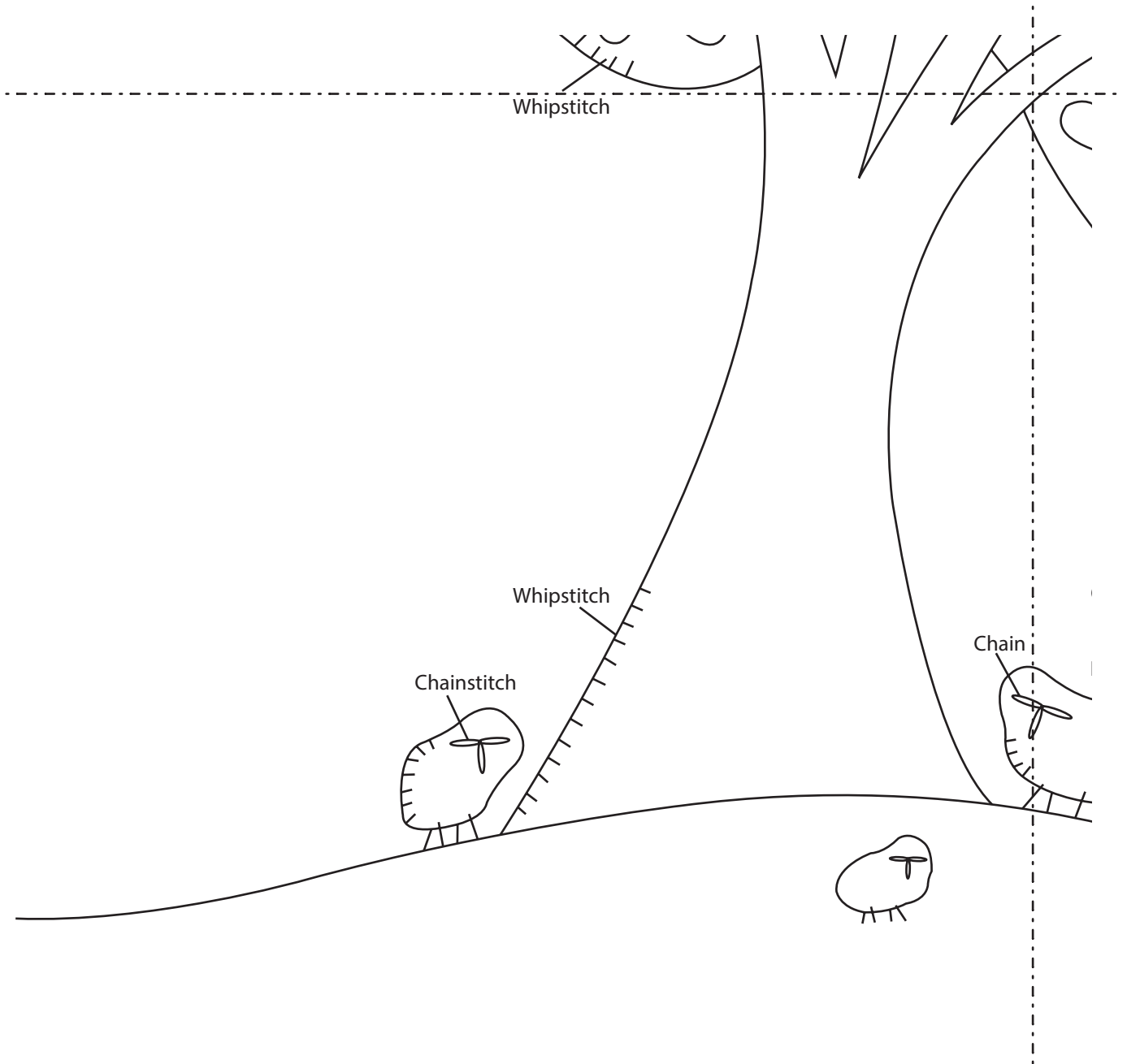
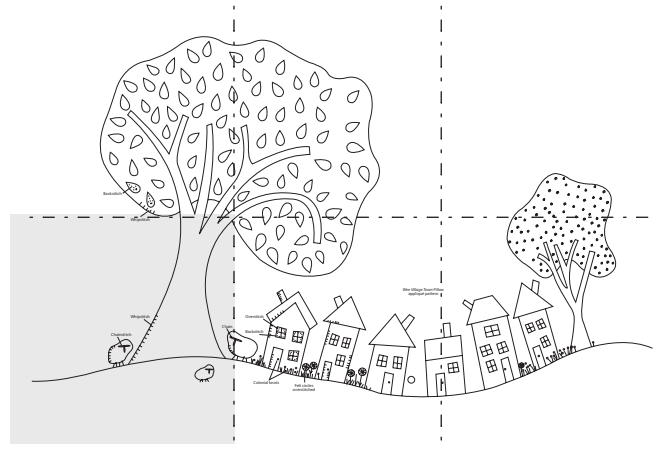
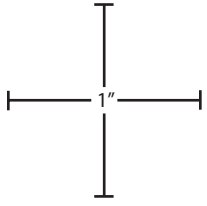

Wee Village Town Pillow

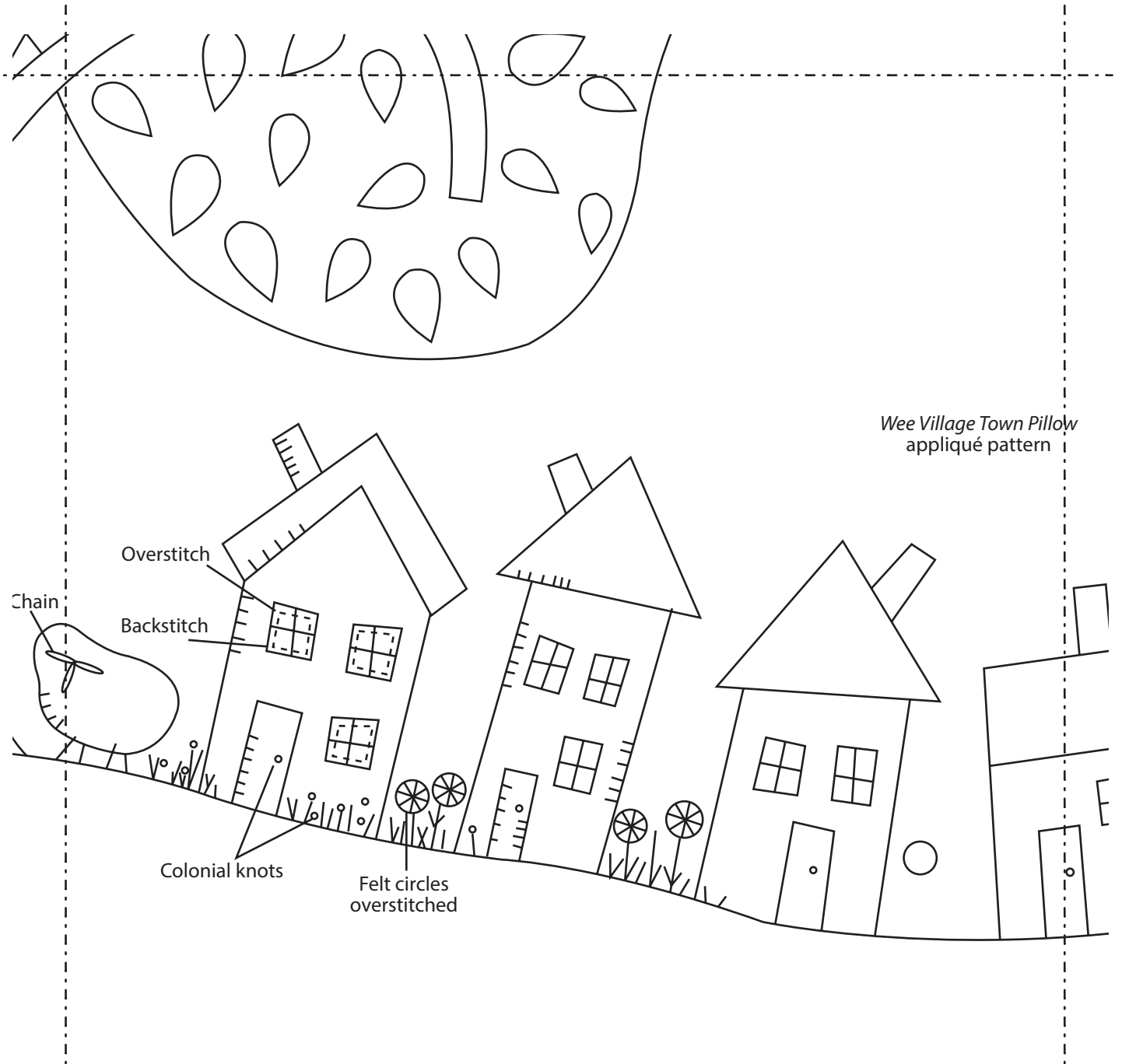
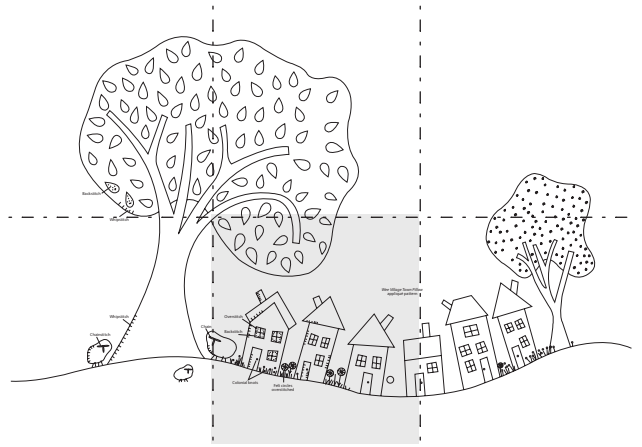
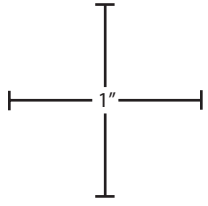

Wee Village Town Pillow

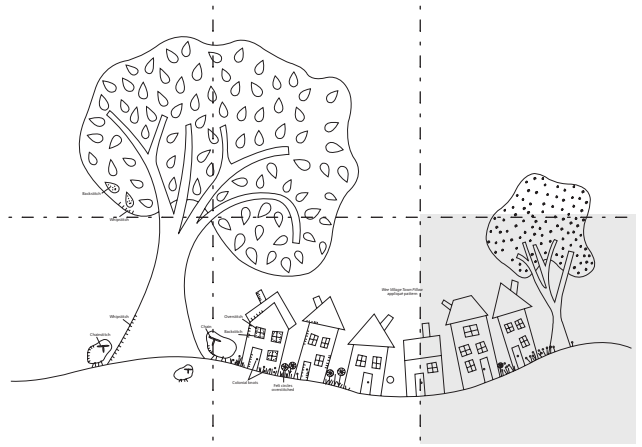
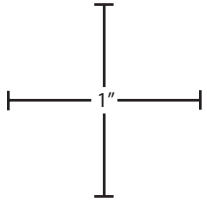

n Pillow
tern